

This PDF is available at <http://nap.edu/25490>

SHARE



## Strengthening Post-Hurricane Supply Chain Resilience: Observations from Hurricanes Harvey, Irma, and Maria (2020)

### DETAILS

136 pages | 7 x 10 | PAPERBACK

ISBN 978-0-309-49458-8 | DOI 10.17226/25490

### CONTRIBUTORS

Committee on Building Adaptable and Resilient Supply Chains After Hurricanes Harvey, Irma, and Maria; Office of Special Projects; Policy and Global Affairs; National Academies of Sciences, Engineering, and Medicine

### SUGGESTED CITATION

National Academies of Sciences, Engineering, and Medicine 2020. *Strengthening Post-Hurricane Supply Chain Resilience: Observations from Hurricanes Harvey, Irma, and Maria*. Washington, DC: The National Academies Press.  
<https://doi.org/10.17226/25490>.

GET THIS BOOK

FIND RELATED TITLES

Visit the National Academies Press at [NAP.edu](http://NAP.edu) and login or register to get:

- Access to free PDF downloads of thousands of scientific reports
- 10% off the price of print titles
- Email or social media notifications of new titles related to your interests
- Special offers and discounts



Distribution, posting, or copying of this PDF is strictly prohibited without written permission of the National Academies Press. (Request Permission) Unless otherwise indicated, all materials in this PDF are copyrighted by the National Academy of Sciences.

Copyright © National Academy of Sciences. All rights reserved.

# STRENGTHENING POST-HURRICANE SUPPLY CHAIN RESILIENCE

Observations from  
Hurricanes Harvey, Irma, and Maria

Committee on Building Adaptable and Resilient Supply Chains After  
Hurricanes Harvey, Irma, and Maria

Office of Special Projects

Policy and Global Affairs

A Consensus Study Report of  
*The National Academies of*  
SCIENCES • ENGINEERING • MEDICINE

THE NATIONAL ACADEMIES PRESS

*Washington, DC*

[www.nap.edu](http://www.nap.edu)

**THE NATIONAL ACADEMIES PRESS 500 Fifth Street, NW Washington, DC 20001**

This activity was supported by contract number 10003990 between the National Academy of Sciences and the Federal Emergency Management Agency (FEMA). Any opinions, findings, conclusions, or recommendations expressed in this publication do not necessarily reflect the views of any organization or agency that provided support for the project.

International Standard Book Number-13: 978-0-309-49458-8

International Standard Book Number-10: 0-309-49458-3

Digital Object Identifier: <https://doi.org/10.17226/25490>

Additional copies of this publication are available from the National Academies Press, 500 Fifth Street, NW, Keck 360, Washington, DC 20001; (800) 624-6242 or (202) 334-3313; <http://www.nap.edu>.

Copyright 2020 by the National Academy of Sciences. All rights reserved.

Printed in the United States of America

Suggested citation: National Academies of Sciences, Engineering, and Medicine. 2020.

*Strengthening Post-Hurricane Supply Chain Resilience: Observations from Hurricanes Harvey, Irma, and Maria*. Washington, DC: The National Academies Press. <https://doi.org/10.17226/25490>.

*The National Academies of*  
**SCIENCES • ENGINEERING • MEDICINE**

The **National Academy of Sciences** was established in 1863 by an Act of Congress, signed by President Lincoln, as a private, nongovernmental institution to advise the nation on issues related to science and technology. Members are elected by their peers for outstanding contributions to research. Dr. Marcia McNutt is president.

The **National Academy of Engineering** was established in 1964 under the charter of the National Academy of Sciences to bring the practices of engineering to advising the nation. Members are elected by their peers for extraordinary contributions to engineering. Dr. John L. Anderson is president.

The **National Academy of Medicine** (formerly the Institute of Medicine) was established in 1970 under the charter of the National Academy of Sciences to advise the nation on medical and health issues. Members are elected by their peers for distinguished contributions to medicine and health. Dr. Victor J. Dzau is president.

The three Academies work together as the **National Academies of Sciences, Engineering, and Medicine** to provide independent, objective analysis and advice to the nation and conduct other activities to solve complex problems and inform public policy decisions. The National Academies also encourage education and research, recognize outstanding contributions to knowledge, and increase public understanding in matters of science, engineering, and medicine.

Learn more about the National Academies of Sciences, Engineering, and Medicine at [www.nationalacademies.org](http://www.nationalacademies.org).

*The National Academies of*  
SCIENCES • ENGINEERING • MEDICINE

**Consensus Study Reports** published by the National Academies of Sciences, Engineering, and Medicine document the evidence-based consensus on the study's statement of task by an authoring committee of experts. Reports typically include findings, conclusions, and recommendations based on information gathered by the committee and the committee's deliberations. Each report has been subjected to a rigorous and independent peer-review process and it represents the position of the National Academies on the statement of task.

**Proceedings** published by the National Academies of Sciences, Engineering, and Medicine chronicle the presentations and discussions at a workshop, symposium, or other event convened by the National Academies. The statements and opinions contained in proceedings are those of the participants and are not endorsed by other participants, the planning committee, or the National Academies.

For information about other products and activities of the National Academies, please visit [www.nationalacademies.org/about/whatwedo](http://www.nationalacademies.org/about/whatwedo).

A valued member of this committee, Dr. M. Sam Mannan passed away unexpectedly during the course of this study. His untimely death was a deeply felt loss to this study, the staff, and the committee members as we all miss his intellectual contributions and his great enthusiasm for this work. Sam brought his many years of experience and vast expertise as a chemical engineer and a dedicated professional to the committee process to enrich and shape the study and its approach, and quickly became an invaluable member of this group. He is remembered as a friend of this committee and a guiding force for supply chain resilience to come. As the committee and staff, we hope that this study does him and his memory proud. We dedicate this volume to his memory.

**COMMITTEE ON BUILDING ADAPTABLE AND RESILIENT SUPPLY  
CHAINS AFTER HURRICANES HARVEY, IRMA, AND MARIA**

**JAMES FEATHERSTONE** (*Chair*), Los Angeles Homeland Security Advisory Council

**ÖZLEM ERGUN**, Northeastern University

**KATHY FULTON**, American Logistics Aid Network

**WALLACE HOPP**, University of Michigan

**PINAR KESKINOCAK**, Georgia Institute of Technology

**BRYAN KOON**, IEM

**ALICE LIPPERT**, Energy Analyst / Independent Consultant

**SAM MANNAN**, Texas A&M University (*deceased, September 11, 2018*)

**CRAIG PHILIP**, Vanderbilt University

**KEVIN SMITH**, Sustainable Supply Chain Consulting

*Staff*

**SHERRIE FORREST**, Senior Program Officer

**LAURIE GELLER**, Senior Program Officer

**LAUREN ALEXANDER-AUGUSTINE**, Program Director

**DANIELLE GOLDSMITH**, Senior Program Assistant

## Preface

In the third quarter of 2017, Hurricanes Harvey, Irma, and Maria revealed some significant vulnerabilities in the national and regional supply chains of Texas, Florida, the U.S. Virgin Islands, and Puerto Rico. This trifecta of disasters tested the capacities of these supply chains and their ability to provide essential goods and services. The broad impacts and quick succession of the three hurricanes also shed light on the effectiveness of the nation's disaster logistics efforts during response through recovery.

Resilient supply chains are crucial to maintaining the consistent delivery of goods and services to the American people. The modern economy has made supply chains more interconnected than ever, while also expanding both their range and fragility. Every day, we move and consume a staggering number of pounds of groceries, gallons of freshwater, tons of fuel, kilowatt-hours of electricity, and myriad pharmaceutical products and medical goods. The procurement and distribution of these materials and capabilities depends on supply chains that are effective and efficient for most consumers. This efficiency is the result of complex and well-ordered networks that, in normal times, are balanced but also vulnerable to a network disruption occurring many miles or days distal to the point of consumption that can be both catastrophic and long-lasting.

Many of the challenges that emerged in 2017 were the result of prior policy and planning strategies that created problems within essential supply chain sectors. Hurricane Harvey revealed how Houston's land use patterns affected supply chain operations; Hurricane Irma brought visibility to the limited number of major transit corridors, which impeded the availability of fuel in South Florida; the U.S. Virgin Islands faced import and reconstruction disruptions from Hurricanes Irma and Maria due to a lack of buffer or alternative capabilities; and the weak pre-storm state of infrastructure exacerbated Puerto Rico's power and communications capacity, which was devastated for months following Hurricane Maria.

Lessons were learned during the 2017 hurricanes that can inform future strategies to improve supply chain management. For instance, it became clear that a working knowledge of the fundamentals and realities of critical supply chains are necessary for crisis logisticians.



*PREFACE*

A number of efforts begun in the wake of these storms will help to ensure that essential supply chains remain operational in the next major disaster, including continuity planning, partnerships between civic and business leaders, mechanisms for more effective communication and information sharing, and investments in critical infrastructure.

This report represents two years of research and collaboration across several regions with a committee representing both academic and applied expertise. Each member provided information, perspective, and context to this issue of growing importance, and their work is much appreciated. We hope that the effort put into this report will result in more adaptive and resilient strategies for addressing the supply chain challenges our nation will face in future disasters.

James Featherstone, Committee Chair

## Acknowledgment of Reviewers

This Consensus Study Report was reviewed in draft form by individuals chosen for their diverse perspectives and technical expertise. The purpose of this independent review is to provide candid and critical comments that will assist the National Academies of Sciences, Engineering, and Medicine in making each published report as sound as possible and to ensure that it meets the institutional standards for quality, objectivity, evidence, and responsiveness to the study charge. The review comments and draft manuscript remain confidential to protect the integrity of the deliberative process.

We thank the following individuals for their review of this report: David Alderson, Naval Postgraduate School; Nezih Altay, DePaul University; Héctor Carlo Colón, University of Puerto Rico, Mayagüez; Ann-Margaret Esnard, Georgia State University; Bradley Ewing, Texas Tech University; Erica Gralla, George Washington University; Stephen Graves, Massachusetts Institute of Technology; Gregory Guannel, University of the Virgin Islands; and Jose Holguin-Veras, Rensselaer Polytechnic Institute.

Although the reviewers listed above provided many constructive comments and suggestions, they were not asked to endorse the conclusions or recommendations of this report nor did they see the final draft before its release. The review of this report was overseen by Susan Hanson, Clark University and Sridhar Tayur, Carnegie Mellon University. They were responsible for making certain that an independent examination of this report was carried out in accordance with the standards of the National Academies and that all review comments were carefully considered. Responsibility for the final content rests entirely with the authoring committee and the National Academies.



# Contents

|  |    |
|--|----|
| SUMMARY  | 1  |
| 1 INTRODUCTION   | 11 |
| 1.1 Study Motivation and Charge to the Committee, 11   |    |
| 1.2 The Study Process, 14  |    |
| 1.3 Organization of the Report, 14   |    |
| 2 CRITICAL CONCEPTS OF SUPPLY CHAIN FLOW AND RESILIENCE  | 17 |
| 2.1 Matching Supply with Demand, 17  |    |
| 2.2 Types of Supply Chain Disruptions, 21  |    |
| 3 OVERVIEW OF SUPPLY CHAIN IMPACTS FROM THE 2017 HURRICANES  | 27 |
| 3.1 Overview of Hurricanes Harvey, Irma, and Maria, 27   |    |
| 3.2 Supply Chain Characteristics That Influence Disruption Vulnerability, 30                               |    |
| 3.3 Comparison of the Hurricane Impacts on Supply Chains in the Four Study Areas, 35                       |    |
| 4 STRATEGIES TO FOSTER MORE EFFECTIVE CONVEYANCE AND DISTRIBUTION OF CRITICAL RELIEF AND RECOVERY SUPPLIES | 51 |
| 4.1 Shifting the Focus, 52   |    |
| 4.2 Building System-Scale Understanding, 56  |    |
| 4.3 Advancing Preparedness, Coordination, and Information Sharing, 66                                      |    |
| 4.4 Providing Essential Training, 78   |    |

CONTENTS

|   |  |     |
|---|--|-----|
| 5 | THE FEDERAL EMERGENCY MANAGEMENT AGENCY'S<br>CURRENT PROGRESS, OPPORTUNITIES, AND CHALLENGES | 85  |
|   | 5.1 Key Advances, 85   |     |
|   | 5.2 The Larger Political and Policy Context, 88  |     |
|   | 5.3 Critical Leadership Roles for FEMA, 88   |     |
|   | 5.4 Conclusion, 89   |     |
|   | REFERENCES   | 91  |
|   | APPENDIXES   |     |
|   | A Speakers from the Committee Meetings   | 95  |
|   | B Overview of the CNA Analyses   | 99  |
|   | C Resources and Tools to Support Information Sharing   | 103 |
|   | D Regulatory Assistance and Relevant Authorities for Disaster<br>Relief by Federal Agencies  | 107 |
|   | E Committee Biographies  | 119 |

## Summary

The goods and services that we all rely on—food at the grocery store, clean water from the tap, gasoline at the pump, power and Internet for homes and businesses, medicines at the pharmacy—are readily available only because of the innumerable processes, systems, and dedicated professionals that keep supply chains flowing. Such systems can be disrupted for a variety of reasons, with extreme weather such as hurricanes being one of the most disruptive threats. The three hurricanes that hit in 2017—Harvey, Irma, and Maria—were each unique and record-setting in their own ways. The fact that these storms occurred in quick succession tremendously stretched the capacity of the Federal Emergency Management Agency (FEMA) and other organizations to respond, and strained the functioning of some supply chains that facilitate the flow of critical commodities and services to affected populations.

FEMA's strategic plan makes clear the agency's growing focus on ensuring that communities have robust, adaptable supply chains that can withstand and recover from the stresses of extreme weather events. To support efforts to translate that goal into effective action, FEMA asked this National Academies of Sciences, Engineering, and Medicine Committee to analyze the functioning of supply chain networks in four primary areas affected by the 2017 storms: South Texas (from Hurricane Harvey), South Florida (from Hurricane Irma), and Puerto Rico and the U.S. Virgin Islands (from Hurricanes Irma and Maria). The committee was asked to identify key lessons from these events related to supply and distribution networks, and to offer recommendations for improving the conveyance and distribution of essential supplies and commodities during disaster response and recovery operations—focused on supply chains for food, fuel, water, and pharmaceutical and medical supplies.

This is a unique National Academies activity in that it was designed as one part of a three-pronged project that also included: (i) a team from the CNA Institute for Public Research conducting background research, data collection, and interviews in order to develop a set of case studies about supply chain issues that unfolded in the four study areas; and (ii) a team from the Massachusetts Institute of Technology's Center for Transportation and Logistics developing an advanced analytic tool that illustrates supply chain nodes that amplify or dampen cascading effects and that aids the analysis of supply chain network structure,

*STRENGTHENING POST-HURRICANE SUPPLY CHAIN RESILIENCE*

linkages, and behaviors. Cross-fertilization of ideas and information among these three efforts strengthens their value as a collective resource for FEMA.

**BASIC SUPPLY CHAIN CONCEPTS**

The fundamental challenge of supply chain management is to match supply with demand in a responsive, accurate, and cost-efficient manner. The ability to meet this challenge can be seriously compromised by disruptive events such as hurricanes. Understanding the mechanics of disruption, as well as options for mitigating the consequences and speeding recovery, requires understanding some key concepts about supply chain dynamics and flows. Two particularly important ones are the bottleneck, the point in a supply chain that limits its flow (or, more formally, the stage in the system with the highest utilization), and the lead time, the duration of time from the initiation of a request for a service or product to its delivery. Under normal conditions, the capacity of a supply chain is determined by its bottlenecks, while the responsiveness of a supply chain is determined by its lead times.

Disruptions to a supply chain can result from several forces, including demand shifts (e.g., spikes in demand for fuel and bottled water), capacity reductions (e.g., when a factory or retail store cannot operate due to damage or power outages), and communication disruptions (due to loss of cell phone, Internet, or point-of-sale systems). The resilience of a supply chain depends on how its bottlenecks and lead times are affected by such disruptions and what capabilities exist for swift restoration after a disruption.

The objective of supply chain resilience is to minimize the impact of such disruptions on the affected population. Policies for achieving this objective can be categorized as readiness (mitigation and preparedness actions to help a system avoid and withstand disruptions), response (emergency relief through the establishment of temporary replacement supply chains), and recovery (the restoration of normal supply chain performance<sup>1</sup> through repair of damaged infrastructure, nodes, links). Knowing how to prioritize among these options requires learning from past experiences and developing systematic analyses of supply chain links and nodes<sup>2</sup> to understand their criticality (the extent to which a disruption of the component will degrade the functionality of the network) and vulnerability (the likelihood a node or link will be disrupted). A node or link that is both critical and vulnerable is a major source of supply chain risk and hence an opportunity for making a supply chain more resilient. By knowing where bottlenecks are likely to emerge and cause critical supply disruptions, one can identify and prioritize actions to mitigate the harm.

---

<sup>1</sup> The reference to “normal” supply chains (used here and throughout the report), simply means the conditions that generally prevailed before the disruptive event—recognizing that economic conditions in any given place can continually evolve and therefore it is not always possible to define an exact pre-storm “set point.”

<sup>2</sup> “Nodes” refer to locations within a supply chain (e.g., a factory, warehouse, distribution center), and “links” refer to the transportation connections between those nodes (e.g., a ship, a truck, a railroad).

## OBSERVATIONS AND LESSONS FROM THE 2017 STORMS

For this study, the committee held meetings in Houston, Miami, San Juan, and St. Thomas to meet with an array of federal, state, and local public officials and managers, private sector stakeholders, and others involved in maintaining the functionality of supply chains before, during, and after the 2017 storms. This input, together with further online engagement with additional experts, and the CNA case study analyses, provided the primary foundation for informing deliberations and developing this report.

The supply chains operating in any particular area have unique profiles based on many factors that can inform, and to some degree predict, how a storm's impact will be felt. This report examines such profiles for the four study areas, focusing on the following broad factors: defining geographical features, directional configuration of the main supply chain links and corridors, concentration of critical nodes and possible points of failure, modal diversity available, and vulnerability of critical infrastructure needed to support supply chain continuity.

There were of course unique impacts and dynamics that unfolded in each of the four study locations.

- In the **Houston** area, Hurricane Harvey's record-shattering floods impeded almost every aspect of supply chain operations and emergency response, revealing an underlying vulnerability that was exacerbated by land use and urban development patterns across the region. Yet at the same time, major problems that could have devastated local, regional, and even national supply chains were averted, in part, due to the region's rigorous systems for disaster preparedness and response, including strong links with key industrial sectors organizations (e.g., the Port of Houston and fuel refineries).
- **South Florida** also benefited from a well-organized system for disaster preparedness and response, with extensive relationships among emergency management officials and industry groups responsible for maintaining the flow of critical goods and services. Nonetheless, Hurricane Irma did expose some important vulnerabilities, for instance, in terms of meeting fuel demand in the face of a massive evacuation, maintaining a sufficient inflow of supplies in the face of serious delivery bottlenecks, and ensuring adequate coordination in the movement of trucks and supplies across state lines.
- The **U.S. Virgin Islands** faced many unique challenges when struck by Hurricanes Irma and Maria, for instance, the heavy dependence on ship imports for critical goods; the difficulties in disposing of storm debris; the lack of housing space for relief workers; the limited port space for processing relief shipments; and the disruption of supply chains for critical reconstruction supplies. Despite these challenges, however, some commercial and relief supply chains operated relatively well, and there



## STRENGTHENING POST-HURRICANE SUPPLY CHAIN RESILIENCE

were many signs of resilience among the population (e.g., local businesses re-opened quickly, and most homes and facilities had working generators, fuel, and cisterns to collect water).

- **Puerto Rico** faced fundamental vulnerabilities that exacerbated the tremendous destruction of Hurricane Maria. For example, there were significant limitations in the coordination of emergency preparedness systems among federal and local agencies and the business community. Fragile, aging power and communications infrastructure were severely damaged, leading to a host of cascading impacts. The Port of San Juan was overwhelmed as large relief shipments poured in while severe bottlenecks limited the distribution of those goods. Some manufacturing plants critical to national supply chains were not prioritized for assistance. Yet many businesses across the island, both large and small, proved impressively resilient and were ready to resume operations quickly after the storm (although still constrained by the prolonged power outages).

Even with the diverse contexts and unique experiences of the different storm-affected areas, there were commonalities in how supply chains were affected across each place considered.

- Post-hurricane bottlenecks and disruptions arose more frequently at the distribution level than at the production level. This is in part because distribution is often carried out by businesses and organizations that are more vulnerable to disruptions (from physical damage to businesses, shortages of delivery trucks and drivers, and diversion of resources to relief efforts). Disruption was also greater at the distribution level because damage to critical infrastructure (e.g., electricity, Internet, municipal water, transportation) often impedes the processing, distribution, and selling of goods.
- Many large companies had invested in continuity planning, partnerships with government officials, employee assistance programs, and resources to harden, back up, and restore critical systems. But small businesses generally had much less capacity to prepare for and avoid supply chain disruptions or to actively engage with local emergency management officials.
- In places where state and local governments invested in reducing the vulnerabilities of critical infrastructure (especially for hardening electric power systems), this did yield benefits in terms of minimizing storm disruptions and thus bolstering the speed with which local economies could resume normal operations. Where these sorts of investments did not occur, more severe disruptions arose.
- The ability of emergency managers to understand post-storm supply chain bottlenecks was constrained by limited pre-storm assessment of vulnerable and critical supply chain nodes, together with information disruptions resulting from power and communication loss. This in turn limited emergency managers' ability to optimally

prioritize the allocation of relief supplies and to know when to stop the push of relief supplies into an area.

- There was confusion in multiple regions around the priorities and practices of FEMA and other emergency management officials for providing generators and fuel to parties in need of assistance—in particular for private sector entities that are critical nodes in local or national supply chains.

These findings helped inform the committee's recommendations, which are aimed at both FEMA and the wide array of state and local officials, private sector decision makers, civic leaders, and others who can play a role in ensuring that supply chains remain robust and resilient in the face of natural disasters.

## **RECOMMENDATIONS FOR ADVANCING SUPPLY CHAIN RESILIENCE IN THE AFTERMATH OF A HURRICANE**

### **Recommendation 1: Shift the focus from pushing relief supplies to ensuring that regular supply chains are restored as rapidly as possible through strategic interventions.**

In the aftermath of a disaster, if the normal supply chains are unable to meet the population's needs for critical items, relief supply chains are established in parallel by FEMA and other organizations to temporarily replace or supplement regular systems for delivering goods and services. Political leaders and citizens typically welcome these relief efforts, as they can be life-saving for impacted communities and are often critical in the hours and days immediately following a disaster. What many fail to recognize, however, is that flooding an area with relief supplies for an extended period—the traditional approach—can have the unintended effect of delaying that area's recovery. This is because relief supply chains often rely on contracting local resources (e.g., trucks, ships, barges, delivery drivers, port storage, and processing space), which are the same resources needed by local businesses to get their supply chains back to normal. The result is that consumers and storm victims may experience a longer recovery period than necessary while waiting for resources to be freed up and reallocated to normal, pre-disaster use. In addition, this traditional approach does not address the “last-mile” distribution problems that are common after major storms. For instance, if key roads are blocked in or near a community, if fuel supplies are short, if power and communications are down, and if workers are not available, then relief supplies often cannot be distributed to those in a community who need help.

This dynamic can be difficult to overcome. First, elected officials who want to ensure that their communities have sufficient food, water, and medical care will often continue to request relief supplies from FEMA even when there is no clear indication that such supplies

*STRENGTHENING POST-HURRICANE SUPPLY CHAIN RESILIENCE*

are needed. Additionally, emergency managers often lack the systems and communications processes needed to gauge the conditions, capabilities, and capacities of local supply chains in a systematic way to understand when the transition from emergency posture back to normal can take place.

As an important step forward, the traditional focus on bringing relief supplies to an affected area to meet unmet demand must be augmented with a focus on understanding the causes of unmet demand—that is, identifying bottlenecks, gaps, and broken links in local supply chains—and pursuing strategic interventions to assist local stakeholders in returning regular supply chains to normal operation as rapidly as possible.

This shift in focus requires improved planning and communications that allow FEMA a clearer view into the resilience, capacities, and limitations of stakeholders in critical supply chains. It may also require changing some current expectations regarding the scope of FEMA's actions. For instance, because damaged critical infrastructure is often the primary factor impeding the operation of supply chains, there needs to be careful consideration of how FEMA could take a more active role in aiding those responsible for infrastructure repair (e.g., to advise the information gathering and analysis needed to identify priorities for infrastructure repairs in an affected area). Likewise, FEMA needs more latitude to prioritize support for key facilities and workers (including in the private sector) that are critical for enabling rapid restoration of local supply chains.

**Recommendation 2: Build system-level understanding of supply chain dynamics as a foundation for effective decision support.**

When planning for and responding to a hazardous event, emergency managers must quickly make numerous critical decisions regarding how to prioritize resources and actions. Making such decisions wisely and strategically requires having a big-picture, system-scale understanding of the supply chains operating within an area. In turn, developing this broad understanding requires gathering and assessing a wide array of information stretching across multiple sectors, across the different stages of the disaster cycle, and across local, state, national, global scales. For instance, before a disaster strikes (“blue skies”) it is important to understand:

- how supply and demand drive the flow of critical goods and services into, through, and out of a given area, and how major disruptions such as hurricanes can affect these flows;
- the criticality and vulnerability of key supply chain nodes, links, and supporting critical infrastructure; and
- dependencies and interdependencies among different supply chain nodes and sectors, and the potential for cascading impacts that may affect the region, state, or even the nation.

During and after a disaster event (“grey skies”) one needs systems to gather real-time information about unfolding impacts (e.g., what roads are blocked, what systems are damaged, what stores are closed, who needs urgent help), and the current capacity of local stakeholders to respond to these impacts.

Modeling frameworks are often needed to integrate these complex data streams and extract practical decision-support information. The growing field of disaster and humanitarian logistics offers some useful examples of the types of models and analytical frameworks needed. Such advances would enhance understanding of supply chain vulnerabilities during preparedness stages and provide better visibility into demand/supply gaps during response stages. They would also enable emergency managers to more effectively prioritize the distribution of critical relief supplies and anticipate possible cascading effects of those decisions. Perhaps most importantly, building system-scale understanding enhances capacity to focus on the strategic restoration of broken links in supply chains and infrastructure, thereby helping normal economic activity rebound quickly.

**Recommendation 3: Support mechanisms for coordination, information sharing, and preparedness among supply chain stakeholders.**

The greatest opportunities for building resilience come from preparedness efforts undertaken before disasters strike. Some examples of critical preparedness actions that businesses or other organizations can take include to develop and regularly update emergency preparedness and continuity of operations plans, conduct training and worst-case scenario drills, test emergency communication protocols and identify workarounds for communications system failures, and develop plans to protect the health and safety of organizational personnel during disaster events. Other critical factors for enabling successful disaster response are clearly defined processes and mechanisms for coordination and information sharing—especially platforms to engage across levels of government and across public and private sector organizations. It takes time to establish the needed relationships and trust, which is why this engagement must begin well before a disaster occurs. The lack of such mechanisms leads to duplication of efforts, gaps in service delivery, confusion over ownership of issues, and in severe cases, competition for scarce resources.

There are in fact many existing mechanisms for government agencies and responders at the local, state, and federal levels to interact with industry in responding to emergencies impacting supply chains. These include, for instance, the Department of Homeland Security’s Critical Infrastructure Threat Information Sharing Framework and Homeland Security Information Network, the Information Sharing and Analysis Centers, and the Sectoral and Regional Consortium Coordinating Councils. Additional formal and informal mechanisms for coordination and information sharing were utilized during the 2017 hurricane season, such as FEMA’s National Business Emergency Operations Center (which hosts voice/web

*STRENGTHENING POST-HURRICANE SUPPLY CHAIN RESILIENCE*

conferences for rapid distribution of high-level information to a broad audience), and many sector- and industry-specific phone conferences, task forces, and online engagement platforms. While each of these mechanisms can provide valuable opportunities for coordination, there needs to be ongoing consideration about how to advance this collective “ecosystem” for engagement to minimize the time burdens placed on individual participants.

**Recommendation 4: Develop and administer training on supply chain dynamics and best practices for private-public partnerships that enhance supply chain resilience.**

Many of the individuals engaged in emergency response have had little or no direct experience working with private sector entities or any training specifically for evaluating the impacts of a disaster (or of the response actions taken) on local supply chains and economic dynamics. University programs in emergency management and homeland security have few classes that provide the insights necessary to understand how disasters and emergency management strategies can impact supply chains and the economy as a whole.

To rectify this situation and help critical stakeholders evaluate the decisions they are making in a broader context, education and training should be provided to emergency managers and those supporting operations in a disaster environment (e.g., emergency operations center personnel, incident management teams, federal coordinating officers, and personnel staffing emergency support functions from other government agencies). This material could be provided through platforms such as new courses in college emergency management programs; orientation training provided to new emergency managers, critical emergency operations center staff and stakeholders, and newly elected government officials; and FEMA’s in-person and online training classes.

These training programs could enable participants to analyze factors such as the main economic drivers within their jurisdiction and the ways their actions can affect broader economic dynamics; data that can inform decisions about priorities for restoration assistance to different private sector and nonprofit supply chains; the ways that different supply chain disruptions can impact economic conditions, locally and at higher levels; and the cost of disaster response or mitigation actions versus the costs of not taking those actions.

## **CONCLUSION**

As FEMA’s internal capacity and expertise on supply chain dynamics grows, the agency can play an increasingly valuable role assisting states, local communities, the private sector, and other stakeholders with technical assistance and guidance across each of the areas discussed in this report. While FEMA itself cannot be responsible for carrying out all of these activities, it can provide leadership for convening, coordinating, and empowering key partners.

This facilitating role should be proactive, going beyond grant programs to also provide jurisdictions with concrete guidance for increasing understanding and capacity to implement new programs. Many state emergency management offices have significant capabilities but lack sufficient information access and sharing. They likewise may have insufficient cooperation with other states, or sometimes even with counties and communities within the state. With FEMA's unique reservoir of experience and cross-jurisdictional scope, the agency could actively advise and guide state and local supply chain preparedness efforts across the country.

As weather disasters are getting costlier, becoming more frequent, and impacting more people, no one government agency can do all that is needed to help communities prepare, respond, and recover. A “whole community” effort is required, involving federal, state, local government agencies, the private sector, and nongovernmental organizations and civic groups, as well as individual households. FEMA's 2018 strategic plan highlights the goal of ensuring that communities have robust, adaptable supply chains that can withstand the stresses of extreme weather events. This goal is best attained by facilitating community-wide efforts to build systems and relationships that advance preparedness. The more advances that are made on these fronts, the less time, energy, and resources will be needed for emergency response and recovery.



## 1

# Introduction

## 1.1 STUDY MOTIVATION AND CHARGE TO THE COMMITTEE

There are numerous goods and services that we all rely on daily and largely take for granted—food from the grocery store, clean water from the tap, gasoline at the pump, power and Internet for homes and businesses, and medicines at the pharmacy. These goods and services are readily available in modern life only because of the processes, systems, and dedicated professionals that keep supply chains flowing. Such systems can be disrupted for a variety of reasons, with extreme weather events such as hurricanes being one of the most disruptive threats.

The three hurricanes that hit in the summer and fall of 2017—Harvey, Irma, and Maria—were each unique and record-setting in different ways. Harvey shattered records for the most rainfall from a tropical cyclone in the United States, inundating southeast Texas. Irma was the strongest Atlantic storm ever observed outside the Caribbean and Gulf of Mexico, and its path across Florida led to the largest hurricane evacuation in U.S. history. Maria was the strongest storm to hit Puerto Rico and the U.S. Virgin Islands in almost a century, causing devastation across the islands. Responding to any one of these storms individually would have required a massive effort, but the fact that they occurred in quick succession (and concurrently with major wildfire disasters in the western United States) tremendously stretched the capacity of the Federal Emergency Management Agency (FEMA) and other organizations to respond. They also strained the functioning of some supply chains that facilitate the flow of critical commodities and services to affected populations.

FEMA's latest strategic plan elaborates the agency's growing interest in helping to ensure that communities have robust, adaptable supply chains that can withstand the stresses of extreme weather events (FEMA, 2018b). Specifically, under the plan's Goal II (ready the nation for catastrophic disasters), Section 2.3 speaks directly to the issue of supply chain resilience: "Posture FEMA and the whole community to provide life-saving and life-sustaining commodities, equipment, and personnel from all available sources" (p. 24). The subsequent



*STRENGTHENING POST-HURRICANE SUPPLY CHAIN RESILIENCE*

discussion illustrates that FEMA is already aware of many critical aspects of supply chain resilience that need to be improved. But translating that general awareness into deep understanding of how to avoid future problems requires a careful examination of lessons learned during recent events.

To aid this examination, FEMA turned to the National Academies of Sciences, Engineering, and Medicine to study the factors that affect private sector supply chains during hurricane events, to examine lessons learned on how private sector and government response plans and planning can best collaborate, and to help advance understanding of factors, such as:

- the state and knowledge of pre-incident networks and capacity of critical supply chains, distribution systems, and infrastructure;
- how these systems were affected by the storms, and how subsequent response actions produced further effects on network integrity and operations;
- the network structures, linkages, and behaviors most adaptable to effective intervention; and
- how supply chain systems can be strengthened in the short term to be efficient in day-to-day operations, and made adaptable to sustain integrated disaster and humanitarian supply chain operations during disasters, especially catastrophic events.

This study was designed to address those needs and to respond to the specific Statement of Task, as shown in Box 1.1. While the primary audience for this study and for the recommendations offered herein is FEMA, some recommended strategies are of direct relevance to other stakeholders involved in building supply chain resilience—including private sector entities involved in the production, distribution, and delivery of critical commodities; local and state emergency management agencies; and nongovernmental organizations and community and civic organizations.

This is a unique National Academies activity in that it was informed by two additional activities that provided data and analysis that contributed to the committee's understanding of the 2017 events, as outlined below.

- The CNA Institute for Public Research, a nonprofit organization providing research and analysis on policy issues important to the nation, was contracted to conduct background research, data collection, and interviews with key actors in the 2017 hurricanes in Texas, Florida, Puerto Rico, and the U.S. Virgin Islands (e.g., interviewing FEMA logistics staff, private sector actors, local and state government emergency management decision makers); to gather information about supply chain function before, during, and after the hurricanes; and to assess emergency management organizations' challenges and strengths. From this information, CNA developed a set of case studies reflecting key supply chain developments that unfolded in the impacted

**Box 1-1**  
**Statement of Task**

A committee will conduct a study to document and understand the strengths and vulnerabilities of the supply chain networks in the four primary areas affected by Hurricanes Harvey, Irma, and Maria in 2017. The study will capture key lessons and observations concerning supply and distribution networks under strain during these hurricane events. These regions include Houston/Galveston, Texas (Harvey); Miami/Fort Lauderdale, Florida (Irma); Puerto Rico (Maria); and the U.S. Virgin Islands (Irma and Maria).

The study will provide options and recommendations for the future swift and effective conveyance and distribution of essential supplies and commodities, and for the restoration of utilities, during disaster response and recovery operations. The work will focus on the conveyance of food, fuel, water, pharmaceutical supplies, and medical equipment. Considering tactical and operational priorities, the report should provide advice that is applicable to the private and public sectors. These recommendations will concentrate on the effective and efficient integration of capabilities and planning between the private sector and government at all levels.

The report will consider implications for supply chain resilience at the regional or national level and geographical and seasonal considerations. Specifically, the report will:

1. Discuss commonalities and differences in how supply chain systems were affected by Hurricanes Harvey, Irma, and Maria in the affected areas of Texas, Florida, Puerto Rico, and the U.S. Virgin Islands.
2. Identify and explain crucial interdependencies, supply chain nodes, and disruptions to supply chains in each of the impacted areas that affected response and recovery.
3. Present options and recommendations for future effective conveyance and distribution of food, fuel, medical supplies, water, and pharmaceuticals, as well as efficient restoration of utilities during disaster response and recovery operations.

areas. This work was published by CNA in the report, *Supply Chain Resilience and the 2017 Hurricane Season* (Palin et al., 2018), and it was shared in public sessions of the National Academies committee. This work is referenced throughout the report, and Appendix B offers more details about the CNA analyses.

- The Massachusetts Institute of Technology's (MIT's) Center for Transportation and Logistics collected data and developed an advanced analytic tool to illustrate points/nodes in the supply chain that amplify or dampen cascading effects in order to aid analysis of supply chain network structure, linkages, and behaviors (based on actual response and recovery efforts) and to help develop options for strengthening supply chains in future hurricane seasons. The committee and the MIT investigators held periodic discussions throughout the study process, thus providing several opportunities for informing each other's thinking during their respective activities.

*STRENGTHENING POST-HURRICANE SUPPLY CHAIN RESILIENCE***1.2 THE STUDY PROCESS**

For this study, the National Academies convened a committee with a diverse range of expertise and experience related to supply chains, emergency management, and disaster response. (For committee members' biographical information, see Appendix E.) Over the course of this study, the committee held six meetings that included open sessions to gather information and perspectives, and closed sessions to deliberate on key messages and work on crafting this report. Meetings were held in each of the locations specified in the committee's charge: Texas (Houston), Florida (Miami), Puerto Rico (San Juan), and U.S. Virgin Islands (St. Thomas). In each location, the committee met with an array of public officials and managers, including numerous FEMA officials, private sector stakeholders, and others involved in maintaining the functioning of supply chains before, during, and after the 2017 storms. In addition, the committee held two online sessions to gather additional information on select topics. This input was invaluable for informing deliberations and development of the report material. See Appendix A for a full list of the experts involved in these meetings.

Meetings also included ongoing updates and discussion with representatives of the CNA and MIT activities described above, to foster iterative learning among those working on the different phases of this activity.

Supply change management and resilience are themselves broad areas of study and practice, and it is beyond the scope of this study to provide a comprehensive review of the research literature associated with these fields. Rather, this study focused more specifically on learning from the practical experiences during Hurricanes Harvey, Irma, and Maria. The discussions and recommendations offered here are based largely on insights from the information provided at the committee's meetings, the CNA analyses, relevant government reports and media accounts about the 2017 events, and the committee's professional insights, experiences, and collective judgment.

**1.3 ORGANIZATION OF THE REPORT**

The major sections of this report are organized as follows.

**Chapter 2** provides an overview of some fundamental concepts related to supply chains in the context of hurricane preparation, response, and recovery. **Chapter 3** provides a brief overview of how the three hurricanes unfolded in the four focal areas for this study; how the different "supply chain geographies" of Texas, Florida, Puerto Rico, and the U.S. Virgin Islands affected vulnerability in each location; how the storms affected key supply chains in each place; and the common dynamics emerging in all the cases studied.

**Chapter 4** presents the committee's recommendations for advancing supply chain resilience and effective conveyance of critical relief supplies in the aftermath of a hurricane. The recommendations are aimed primarily at emergency management professionals, as opposed to the many (often volunteer-based) groups and individuals that may be involved in local-scale, immediate stages of emergency response. These emergency management professionals who can help ensure the resilience of critical supply chains in the face of disaster events are based not only in FEMA, but also in numerous state and local agencies, and private sector and nongovernmental organizations. **Chapter 5** discusses some of the important steps forward that FEMA and others are already making toward the resilience goals discussed in this report, as well as aspects of the broader policy landscape that may influence further advances.



## 2

# Critical Concepts of Supply Chain Flow and Resilience

## 2.1 MATCHING SUPPLY WITH DEMAND

A supply chain facilitates the timely flow of materials and products from suppliers to manufacturers to distributors (wholesalers) to distribution channels (e.g., retailers, clinics/hospitals, nongovernmental organizations), and finally to end users. It does this by transmitting demand information upstream (and other related information downstream) to guide production, transportation, and distribution decisions. Figure 2.1 illustrates the material and information flows in a typical supply chain under normal conditions.

The fundamental challenge of supply chain management is to match supply with demand in a responsive, accurate, and cost-efficient manner. Two features of supply chains complicate this fundamental challenge, both under normal conditions and, especially, under emergency conditions like those posed by a hurricane. These include demand variability and cycle time.

- *Variability* refers to fluctuations in both demand and supply over time. Some sources of variability are predictable (e.g., seasonal demand shifts or scheduled downtime for equipment maintenance), while others are unpredictable (e.g., individual customer demand decisions or sudden equipment failures). Variability occurs in the transportation phase as well as production processes of a supply chain.
- *Cycle time* is the total time from start to finish of a process.<sup>1</sup> For example, the manufacturing cycle time for a component is the time from when an item is ordered to when it is shipped, which includes both queue times while the item is waiting

---

<sup>1</sup> Flow time, manufacturing lead time, and production lead time are often used synonymously with cycle time. Regardless of the nomenclature, cycle time can refer to the start-to-finish time of any well-defined process, including a single production step (e.g., machining station), a full production line, or an entire supply chain.

## STRENGTHENING POST-HURRICANE SUPPLY CHAIN RESILIENCE

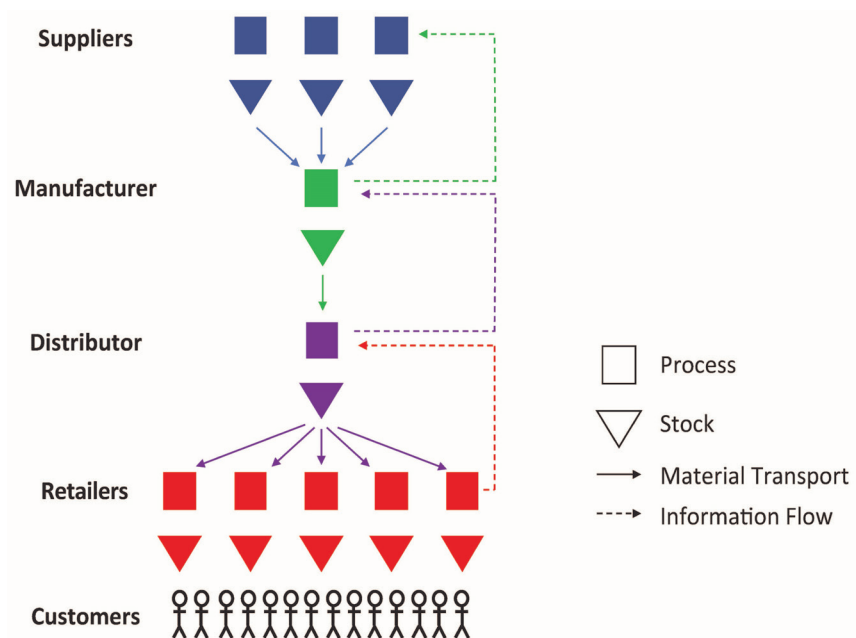

**FIGURE 2.1** Schematic of a supply chain under normal conditions.

for manufacturing processes to become available and manufacturing times when the item is actually being worked on. Because cycle times for production, transportation, and distribution processes in a supply chain are non-zero, decisions about what to make, ship, and sell must be made before customer demands occur.

If demand variability were entirely predictable, with no deviation between planned and actual production, it would be possible to make supply chain decisions that precisely adjust supply to meet demand. However, because all supply chains involve at least some unpredictable variability in demand, many supply chain decisions must be made on the basis of demand forecasts. And because forecasts are never perfect, it is impossible to precisely match supply with demand, even under the best of conditions. In complex systems that span multiple geographical locations and have different firms involved in the decisions (e.g., raw material producers, component manufacturers, transporters), demand variability is more unpredictable and lead times are longer, causing the fundamental challenge of supply chain management to become even more difficult.

In response to these challenges, modern supply chains are making increasing use of large-scale integrated information systems, responsive production and transportation systems, and sophisticated inventory control systems to guide design and control decisions. However, these advanced information and logistics systems alone are not sufficient to manage a

supply chain. To focus these tools on the most critical elements of the supply chain, and to understand the potential impacts of a disruptive event, supply chain managers also need to understand some basic concepts about flows.

## Bottlenecks

One of the most important of these concepts is that of a bottleneck. Intuitively, the bottleneck can be understood as the point in a supply chain that limits its flow. This bottleneck could be the production process for a raw material, component, or finished product, or the transportation process between any of the stages in the supply chain, or even the distribution process (e.g., retail outlets). Because bottlenecks have so much influence on the behavior of supply chains, under both normal and disrupted conditions, it is helpful to define them more precisely. To do this, we introduce the concepts of processes, capacity, and utilization:

- A *process* in a supply chain refers to a production, transportation, or distribution system that makes, moves, or delivers goods and services. Process stages can be parallel (e.g., multiple manufacturers and retailers) or serial (e.g., machines within a factory or legs in a transportation route). Figure 2.1 provides a schematic of a supply chain where the boxes represent the main stages in the process, solid arrows represent material flows, and dotted arrows represent information flows.
- The *capacity* of a process stage is the maximum rate at which it can produce/move product. This can be measured in widgets per week or any number of other metrics that represent flow per unit time.
- The *utilization* of a process stage is given by the ratio of demand rate to capacity. When this ratio is less than or equal to 100 percent, it represents actual utilization—the fraction of time the resource is busy over time. Since actual utilization cannot exceed 100 percent, when the ratio is above 100 percent, this indicates the extent to which the resource is overloaded.

The bottleneck of a supply chain is defined as the process stage with the highest utilization. Because it is the busiest stage, the bottleneck is the part of the supply chain most vulnerable to becoming overloaded as the result of a spike in demand or a loss of capacity. However, a process stage need not be overloaded all of the time to be a bottleneck. Under normal conditions, the most heavily utilized process stage (the bottleneck) will always have average capacity larger than average demand (will always have utilization of less than 100 percent), otherwise an ever-increasing backlog of demand would build up, which is obviously unsustainable. Nevertheless, even when the bottleneck has enough capacity to keep up with demand on average, the closer its utilization is to 100 percent, the more frequently the system will experience intervals over which demand exceeds capacity, leading to backups and delays that inflate the cycle time.



*STRENGTHENING POST-HURRICANE SUPPLY CHAIN RESILIENCE*

Another characteristic of bottlenecks is that they are dynamic. As system parameters change over time, such as staffing levels, consumer demand, the mix of products in the supply chain, and other parameters, utilizations of the various process stages within the supply chain will naturally fluctuate. This can cause the bottleneck to shift from one stage to another; it is common for disruptions such as those caused by hurricanes to shift the bottleneck. For this reason, supply chain managers need to be aware of “near bottlenecks” (process stages whose utilization is almost as high as that of the bottleneck), because these can easily become rate-limiting stages in the supply chain.<sup>2</sup>

By identifying the process stages of critical supply chains that are at risk of becoming bottlenecks, one can better pinpoint and prioritize actions to harden supply chains against disruption; and by identifying bottlenecks that arise after a disruptive event, one can focus on strategic efforts to return the supply chain to normal operations.

**Inventory and Lead Time**

Another factor that is key to understanding normal and emergency behavior of supply chains is inventory, the quantity of material (raw materials, components, or finished goods) stored at any point in the supply chain.<sup>3</sup> Some inventory in a supply chain is the result of variability in the demand and production processes. Whenever production outpaces demand, inventory builds up. When demand outpaces production, the inventory buildup is drawn down. All supply chains contain such inventory, which supply chain managers seek to keep low in the interest of cost efficiency. But inventory is also held deliberately in supply chains to improve responsiveness to end users. While responsiveness from a production perspective is measured by cycle time, responsiveness from an end user standpoint is measured by lead time, which is the duration of time from the end user’s request for a service or product to its delivery.

When inventory is present in a supply chain, lead time can be shorter than the corresponding cycle time. For example, the lead time seen by a customer who orders an assemble-to-order laptop computer might be one week. If the customer bought the same computer from a retail store that had it in stock, the lead time would be zero. However, the cycle time to produce the computer, all the way from sand to silicon to semiconductors to circuit boards to laptop could take one year or more. Inventories of raw materials, components, in-process products, or finished goods can dramatically shorten, or even eliminate, customer lead time to receive a product.

---

<sup>2</sup> Another reason to be aware of near bottlenecks is that, in practice, our understanding of capacity and utilization is only an estimate; hence, a stage that may seem to have lower utilization than the estimated bottleneck may, in some cases, actually be the bottleneck.

<sup>3</sup> Inventory, also commonly called “stock,” is often measured in units of time rather than quantity. For example, a tank that contains 30,000 gallons of fuel in a system that uses an average of 5,000 gallons per day is said to have six days of inventory.

What does this mean for emergency response? Under normal conditions, the capacity of a supply chain is determined by its bottlenecks, while the responsiveness of a supply chain is determined by its lead times. How resilient the supply chain is to disruptions, such as hurricanes, depends on how these bottlenecks and lead times are affected by the disruption and what capabilities exist to restore them after the disruption.

## 2.2 TYPES OF SUPPLY CHAIN DISRUPTIONS

An extreme event such as a hurricane can disrupt a supply chain in three primary ways.

- ***Demand shift:*** A hurricane can distort demand patterns before and after the storm. Demand for gasoline, generators, batteries, and food items often spikes before a hurricane, while demand for bottled water, chainsaws, garbage cans, tarps, and other recovery supplies are usually elevated afterwards. Such demand spikes can push utilization of bottlenecks above 100 percent, even if only some parts of the supply chain are disrupted by the storm.
- ***Capacity reduction:*** Examples of capacity reductions that occur in the wake of a hurricane include a production or transportation process that is limited by lack of plant, power, or people: a factory (plant) unable to produce due to physical damage, a retail outlet unable to store perishable products due to lack of electricity (power), trucks unable to deliver goods for lack of drivers (people). Each of these instances was a factor following Hurricane Maria in Puerto Rico.
- ***Communication disruption:*** A hurricane can interrupt the normal channels by which information is communicated up the supply chain. For example, normal operations of a supply chain can be impeded by power or cell phone outages, broadband interruptions, point-of-sale system failures, and absence of key individuals. Furthermore, the exceptional relief supply chains established to deliver essential products in the wake of a hurricane lack the sophisticated communication systems utilized in many commercial supply chains,<sup>4</sup> and therefore struggle to match supplies with demand.

Each of these supply chain disruptions can reduce capacity and lengthen lead time. Shifts that elevate demand for some products, and disruptions that reduce capacity of some processes, will increase utilization at one or more stages of the supply chain, possibly creating new and more severe bottlenecks. Higher utilization will inflate cycle time and, depending on inventory levels, may also increase lead time and result in delays in getting products to people. If the

---

<sup>4</sup> These include, for instance, advanced planning and scheduling systems that help supply chain managers ensure that raw materials and production capacity are optimally allocated to meet demand.

STRENGTHENING POST-HURRICANE SUPPLY CHAIN RESILIENCE

bottleneck utilization exceeds 100 percent, then the supply chain will be unable to keep up with demand, leading to shortages that will not be filled until after capacity is restored. Disruption of communications can further exacerbate the problem by obscuring information about demand and stock levels, making it impossible to direct the available supplies to the users that need them most.

Figure 2.2 schematically describes a scenario in which a disaster-related supplier outage, possibly exacerbated by amplified demand, has resulted in a severe bottleneck at a single supplier, which has led to lack of product availability at the retail level. This is a simplified representation of reality, however, in that processes are represented as simply on/off, which neglects the possibility that a disruption could reduce the capacity of a process rather than eliminate it.

Figure 2.3 illustrates the path by which the supply chain in Figure 2.1 could be transformed into the supply chain in Figure 2.2 as stocks in the system depleted in cascading fashion over time. Restoration of the supply chain to its original operation in Figure 2.1 would involve similar time lags in reverse. This cascading phenomenon can play an important role in determining the

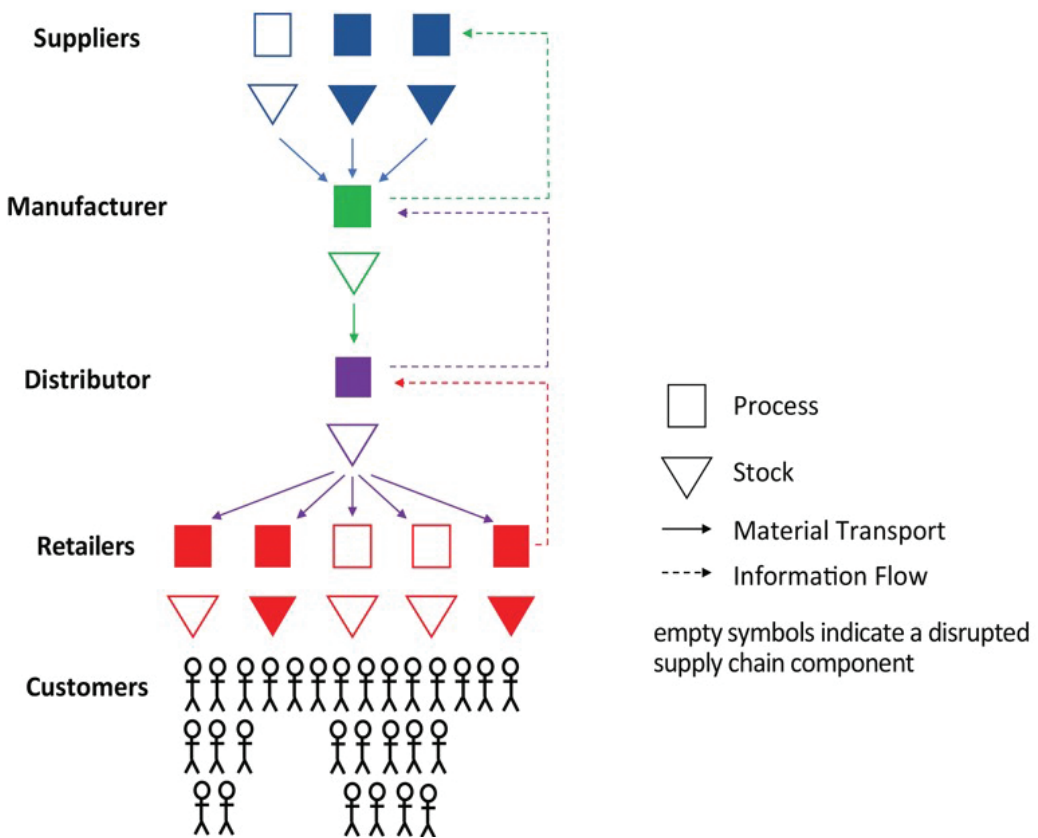

FIGURE 2.2 Schematic of a disrupted supply chain.

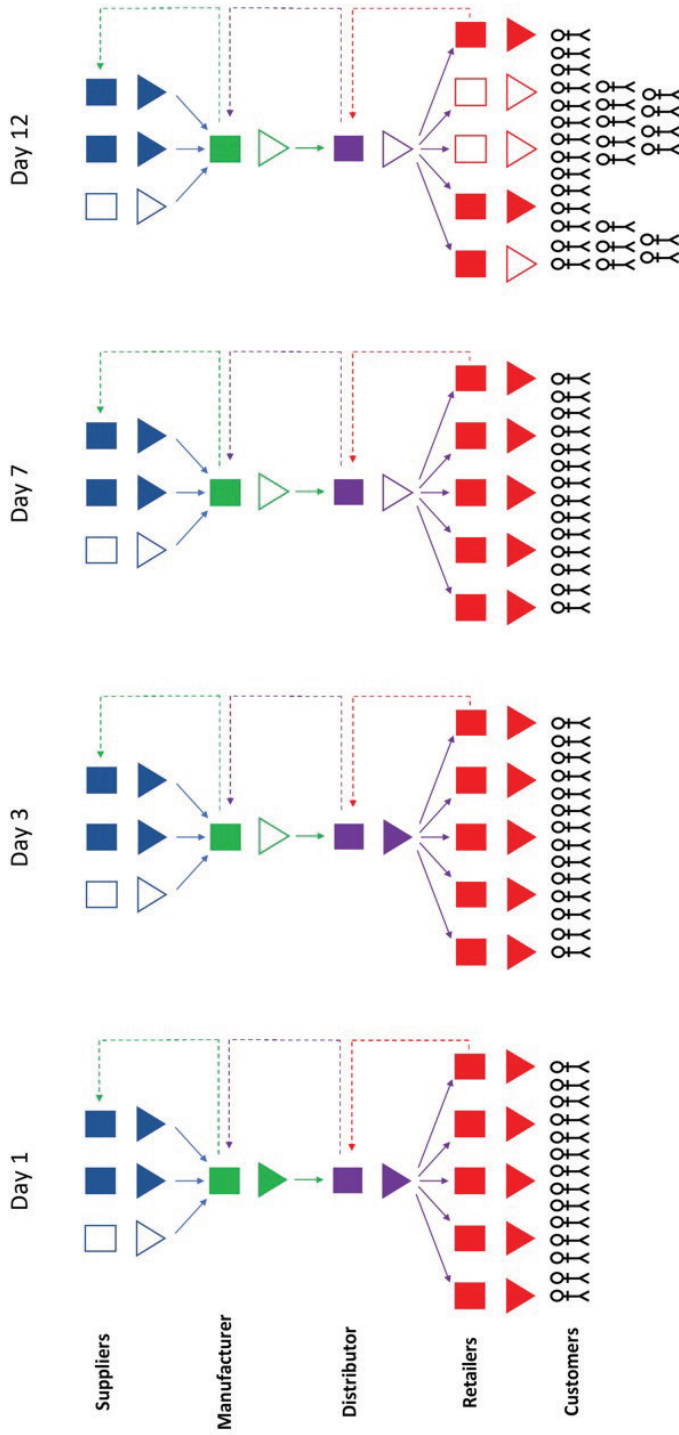

FIGURE 2.3 Example of cascading failure in a supply chain.

## STRENGTHENING POST-HURRICANE SUPPLY CHAIN RESILIENCE

severity of supply shortages after a hurricane. For example, if fuel inventories are high at intermediate depots at the time of a hurricane, an affected region may not feel the effects of a limited pipeline outage, because the time for the outage to cascade to the end user is longer than the time to bring the pipeline back online.

Figures 2.2 and 2.3 illustrate a simple scenario in which a single supply node has been disrupted and the effect has cascaded through the supply chain. It is representative of the impact of a hurricane on users outside the affected region.<sup>5</sup> In reality, hurricanes often disrupt many nodes and links at once. In particular, damage to critical infrastructure (e.g., the electrical grid, fuel supply network, water delivery system, communication networks, and transportation systems) can bring down a wide swath of production and transportation processes. For example, a power outage could disrupt some manufacturing facilities directly and disrupt others indirectly, by disrupting gas stations and making it impossible for workers to get to their jobs. When such correlated disruptions occur, hundreds or thousands of bottlenecks can appear, leading to the interruption of a wide range of supply chains. It is particularly important to direct resilience efforts at these critical systems on which all other supply chains rely.

The objective of supply chain resilience initiatives is to minimize the impact of a disruptive event (e.g., a hurricane) on the affected population and to do so as efficiently as possible. Policies for achieving these can be classified into three categories.<sup>6</sup>

- **Readiness:** Examples of steps that can be taken in advance of a hurricane include building up inventories of components and/or finished goods as protection against capacity outages (a strategy often employed by emergency managers through “pre-positioning” of critical supplies in or near the affected area), and hardening key production and distribution processes (e.g., equipping selected service stations or gas pumps so they will be able to dispense fuel during a power outage).
- **Response:** The classic response to the need for emergency goods and services in the wake of a hurricane is to set up special relief supply chains. Government agencies (FEMA, Army Corps of Engineers, state governments) and nongovernmental organizations (e.g., American Red Cross, Catholic Charities, Feeding America, National Baptist Convention) deliver food, water, medical services, and many other essential

<sup>5</sup> The scenario shown in Figures 2.2 and 2.3 could be seen as a stylized version of the shortage of intravenous saline bags created by Hurricane Maria’s disruption of manufacturing plants in Puerto Rico at the end of September 2017. Due to inventories in the supply chain, shortages at the hospital level did not become widespread until the end of 2017 and persisted well into 2018.

<sup>6</sup> Here we use the term “readiness” to encompass activities often labeled as either “preparedness” or “mitigation”, with both referring to actions that can prevent or reduce risks of harmful impacts from a disaster. While there are varying definitions of these terms, in the context of supply chain resilience, we think of mitigation as applying primarily to investments in hardening or upgrading physical infrastructure (e.g., for power, communications, transportation, and water supply) and preparedness as applying primarily to actions or policies that strengthen social wellbeing (e.g., educating households and businesses on how to prepare for a hurricane).

commodities to disaster-stricken communities. The special-purpose relief supply chains used by these organizations can undoubtedly save lives and reduce human suffering. They are, however, less efficient and less precise in meeting demands than the supply chains they attempt to replace.

- **Recovery:** Because regular supply chains have been optimized over time in response to profit motivation and market competition, they will always be more efficient at matching supply with demand than special-purpose emergency supply chains. Hence, a vital management response is to restore these supply chains as quickly as possible. The private sector will often seek to do this in service of companies' business objectives. But a lack of coordination among government, nongovernmental organizations, and private companies can slow the restoration of regular supply chains. For example, if public relief efforts utilize a significant portion of local truck drivers, private supply chains will be slow to return to normal.

The conceptual representations of supply chains and framework for increasing their resilience in the face of a major disruption can help decision makers understand and systematically assess the management alternatives for dealing with supply chain bottlenecks. However, while this framework is useful for identifying candidate policy options, it is less useful for actually prioritizing among those options. This is because it is difficult to know where bottlenecks exist or will emerge as the storm and immediate aftermath are playing out; it is also difficult to assess the full impacts of a given activity on the reinforcement, replacement, or repair of a bottleneck. Therefore, making the best use of resources to enhance supply chain resilience also requires the strategic use of data.

One important source of data is past experience. Leveraging lessons learned from previous hurricanes can inform the development of policies for dealing with future events. Although each event is different, identifiable patterns recur (e.g., power outages close retail food and fuel outlets). These events also provide evidence of the efficacy of various policies (e.g., evacuation orders, "war room" coordination panels, mobile pantries). A second source of data is "fault tree" analysis of the critical supply chains in regions at risk of hurricanes, used to identify the links in the supply chain that are most likely to become bottlenecks. To frame such an analysis, it is helpful to introduce the following concepts.<sup>7</sup>

- **Criticality** of a network node, link, or other component measures the extent to which a disruption of the component will degrade the functionality of the network (which could be measured as the on-time delivery of supply to the end customer). For example, the production process of a sole-sourced component is more critical

---

<sup>7</sup> Fault tree analysis is a top-down, deductive analysis method used to understand how systems can fail and to identify the best ways to reduce risk of a particular system-level (functional) failure.

## STRENGTHENING POST-HURRICANE SUPPLY CHAIN RESILIENCE

than the production process for a multi-sourced component for which other suppliers can meet much of the demand. A precise measurement of criticality for supply chain nodes and links is difficult<sup>8</sup> since it depends on a variety of network and supply/demand characteristics that can shift over time (Alderson, 2008). But a simple way to think about criticality is to identify process stages in a supply chain for which significant reductions in capacity will lead to severe bottlenecks. This helps us recognize, for instance, that a supply node for which a ready backup exists is not critical because its failure will not result in a bottleneck.

- **Vulnerability** measures the likelihood that a node or link will be disrupted. For example, a production facility in a hurricane-prone region is more vulnerable than one that is not in a hurricane-prone region; and facility with sophisticated fire protection is less vulnerable than one without. The goal is not to insist on accurate estimates of failure probabilities, but instead to call out nodes and links with significant risk of being disrupted.

A node or link that is both critical and vulnerable constitutes a major source of risk that a disruption could cause adverse impacts on a supply chain. Addressing such risks is a key opportunity to make a supply chain more resilient.

In tying all these different supply chain concepts together, we note that if one has capacity to foresee where bottlenecks are likely to emerge and cause supply disruptions, and to foresee a system's most critical and vulnerable links and nodes, one can then identify readiness, response, and recovery actions to mitigate the harm. For example, if diminished trucking capacity caused by a power outage at retail diesel fueling stations is identified as likely to impede the delivery of supplies to an affected region, several remediations emerge. A readiness policy might be to encourage (via regulation and/or subsidies) on-site generators at key fueling stations. A response policy might be to set up portable fueling stations along critical routes. A recovery policy might give repair priority to portions of the grid that supply key fueling stations.

The fundamental supply chain concepts explored in this chapter are reflected in many of the events that unfolded in the aftermath of the 2017 hurricanes, including the examples discussed in Chapter 3. These concepts likewise are important to understand as foundations for the supply chain resilience strategies recommended in Chapter 4.

---

<sup>8</sup> Some criticality measures based on network connectivity do exist, however (Borner et al., 2007).



## 3

## Overview of Supply Chain Impacts from the 2017 Hurricanes

**W**hile hurricanes are not new to communities across the Caribbean and southeastern United States, the 2017 storm season will be long remembered. There were 17 named storms that season, and the 3 most impactful—Hurricanes Harvey, Irma, and Maria—were unprecedented in different ways. Each storm individually posed substantial challenges to emergency management officials, and their occurrence in such quick succession stretched response capacities tremendously. A large part of this challenge was managing the movement of relief supplies and supporting the supply chains that provided the basic commodities necessary for survival.

This chapter provides a brief overview of what transpired as these three storms struck in the focal areas for this study: Texas, Florida, Puerto Rico, and the U.S. Virgin Islands. It then discusses how physical geography and supply chain characteristics influenced the vulnerability of each location to disruptions from the storms. The chapter concludes by exploring the differences and similarities in how critical supply chains were affected in each place by the different storms.

### 3.1 OVERVIEW OF HURRICANES HARVEY, IRMA, AND MARIA

Below is a recap of how the historic 2017 hurricanes unfolded in the four focal areas for this study (drawing largely from more detailed summaries provided in the CNA investigations that were part of this study). Figure 3.1 shows the three hurricanes' paths and dates.

#### **Hurricane Harvey**

Harvey made landfall as a Category 4 storm near Rockport, Texas, on August 25, 2017, with winds reaching 152 miles per hour and storm surges in the range of 5 to 10 feet. Most of



## STRENGTHENING POST-HURRICANE SUPPLY CHAIN RESILIENCE

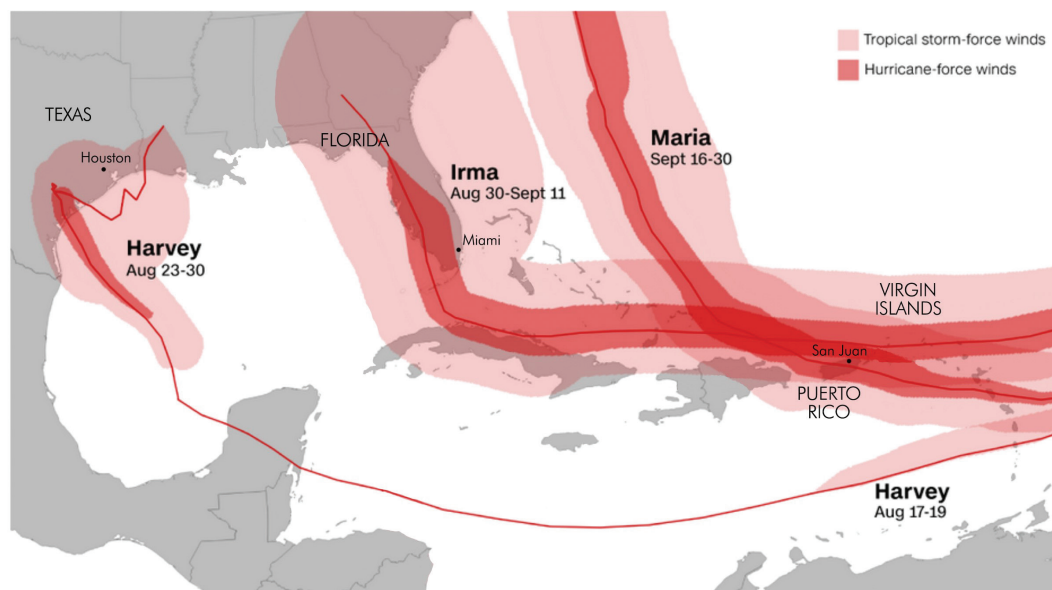

**FIGURE 3.1** Tracks and dates of the three hurricanes that are the focus of this study.  
SOURCE: National Weather Service / U.S. Census Bureau.

the initial wind and wave damage affected the Coastal Bend area. Over the next several days, the storm then drifted back out toward the Gulf of Mexico, made a second landfall near the Texas-Louisiana border, and stalled over Houston—during which time the region received more than 50 inches of rainfall (five-day rain totals exceeded 64 inches in Nederland, Texas), shattering previous U.S. rainfall records. Massive flooding occurred across Houston, Beaumont, and many other communities in southeast Texas. Virtually the entire nation’s helicopter search-and-rescue resources were deployed to Texas, and there were thousands of aerial and water evacuations of stranded residents. Stagnant floodwaters blocked roadways and damaged 204,000 homes,<sup>1</sup> forcing tens of thousands of people into shelters. Hurricane Harvey also flooded 800 wastewater treatment facilities and 13 Superfund sites, spreading sewage and toxic chemicals into the flooded areas.<sup>2</sup> Hurricane Harvey was estimated to cause more than \$125 billion in damages, making it the second most costly storm in U.S. history (after Hurricane Katrina in 2005), and the emergency management response was one of the largest in our nation’s history.

<sup>1</sup> See <https://www.houstonchronicle.com/news/article/In-Harvey-s-deluge-most-damaged-homes-were-12794820.php>.

<sup>2</sup> See [https://www.washingtonpost.com/news/post-nation/wp/2017/09/03/trump-administration-wants-to-tie-harvey-recovery-aid-to-debt-ceiling-legislation/?utm\\_term=.683e23ab5a0d](https://www.washingtonpost.com/news/post-nation/wp/2017/09/03/trump-administration-wants-to-tie-harvey-recovery-aid-to-debt-ceiling-legislation/?utm_term=.683e23ab5a0d).

## Hurricane Irma

Irma reached hurricane strength on August 31, 2017. By September 5, it had rapidly intensified, with sustained wind speeds of 185 mph, becoming the strongest hurricane ever observed in the Atlantic Ocean. Irma maintained Category 5 winds for three days as it moved west, and on September 6 it slammed the U.S. Virgin Islands. The island of St. Thomas in particular suffered widespread destruction. Hurricane Irma passed just north of Puerto Rico, knocking out the island's fragile, aging electricity system and leaving more than 1 million people without power.<sup>3</sup> During this time, evacuations began from high-risk areas in Florida, eventually reaching 6.8 million evacuees, the largest in the state's history. On September 10, Irma made landfall at Category 4 strength in the Florida Keys, where it caused extensive damage. Hurricane-force winds extended up to 80 miles from the center, and tropical storm-force winds extended outward up to 400 miles, affecting nearly the entire Florida peninsula. As Irma advanced across Florida, severe flooding, storm surges, and tornadoes occurred across numerous counties. The storm's huge size and rapidly changing track created unprecedented challenges for the region's emergency management officials.

## Hurricane Maria

Less than two weeks after Irma, Maria was declared a hurricane, and warnings were issued across the Caribbean. The storm continued to strengthen, and on September 19, 2017, Hurricane Maria passed over St. Croix in the U.S. Virgin Islands, destroying much of the island's buildings and communications and power infrastructure. On September 20, Maria made landfall in Puerto Rico, still at Category 5 strength. The storm moved slowly across the island, dumping more than 30 inches of rain. By the time it eventually weakened, the entire island's power infrastructure was destroyed, and 100 percent of customers had lost service. Over the course of the next few days, the Puerto Rico Electric Power Authority worked with the Department of Energy, the Department of Defense, and FEMA to distribute fuel and generators in order to keep critical infrastructure online across Puerto Rico and the U.S. Virgin Islands. As ports and airports reopened over the coming days, more shipments of critical relief supplies were brought in. In late September and early October, the Department of Defense provided a large contingent of employees to support response efforts in the U.S. Virgin Islands, including bringing the Navy ship *Comfort* to San Juan for additional medical support. However, it was not until many months later that services for potable water, electricity, and cell phone connection were fully restored across the islands.

---

<sup>3</sup> See <https://www.wired.com/story/puerto-rico-hurricane-maria-recovery/>.

## STRENGTHENING POST-HURRICANE SUPPLY CHAIN RESILIENCE

**3.2 SUPPLY CHAIN CHARACTERISTICS THAT INFLUENCE DISRUPTION VULNERABILITY**

Just as each storm has a unique fingerprint, the supply chains operating in any particular area have unique profiles based on many factors, including the area's physical geography and historical development patterns as well as the strength and response capacity of critical public and private sector networks. This profile can inform, and to some degree predict, vulnerabilities and ways in which a storm may impact the area. Below are some examples of comparative supply chain profiles in the different regions covered in this study, focusing on a series of broad "meta-factors" of key importance to the functioning of supply chains.<sup>4</sup> The main focus in this section is on physical geographical factors and not the far more complex social characteristics of the four locations (e.g., the vitality, organization, resources, and capacity of the public and private sector institutions relevant to supply chains and emergency response).

**Defining Geographical Features**

This element involves an area's geographical features that drive patterns of connectivity, both within an area and with other neighboring areas. With respect to the locations considered in this study, the differences are stark (see Figure 3.2).

- *South Texas.* Houston is highly flood-prone due to low elevation and flat topography, which offer no natural physical drainage pathways for intense rainfall. (During Hurricane Harvey, the city's bayous and drainage systems quickly filled, leading to rapid flooding of freeways and roads.) These flooding risks have been exacerbated by sprawling development patterns that displaced wetlands and other green spaces with impervious concrete and asphalt surfaces. The Texas coastline is long and exposed, but accessible from inland areas, and thus not largely dependent on water-bound shipments when relief efforts are needed. Inland evacuation is a possibility. At the same time, the region's widely dispersed residential, commercial, and industrial development patterns means that the distribution of goods and services requires considerable, reliable road transport capacity. When roadways are cut off by flooding, normal supply chain systems can quickly become paralyzed.
- *Florida.* Much of Florida is similarly flood-prone due to low elevations and development patterns that undermine natural drainage systems. South Florida has underlying porous limestone that allows floodwaters to arise from underground and has coastal exposure to both Atlantic and Gulf Coast storms. As an 800-mile long, densely developed peninsula with just a few main transport corridors, Florida's

---

<sup>4</sup> Here Puerto Rico and the U.S. Virgin Islands are grouped together because they share many common characteristics, but there are of course important differences between the two locations; for example, Puerto Rico's local distribution problem was vastly more complex and the impacted population was significantly larger.

OVERVIEW OF SUPPLY CHAIN IMPACTS FROM THE 2017 HURRICANES

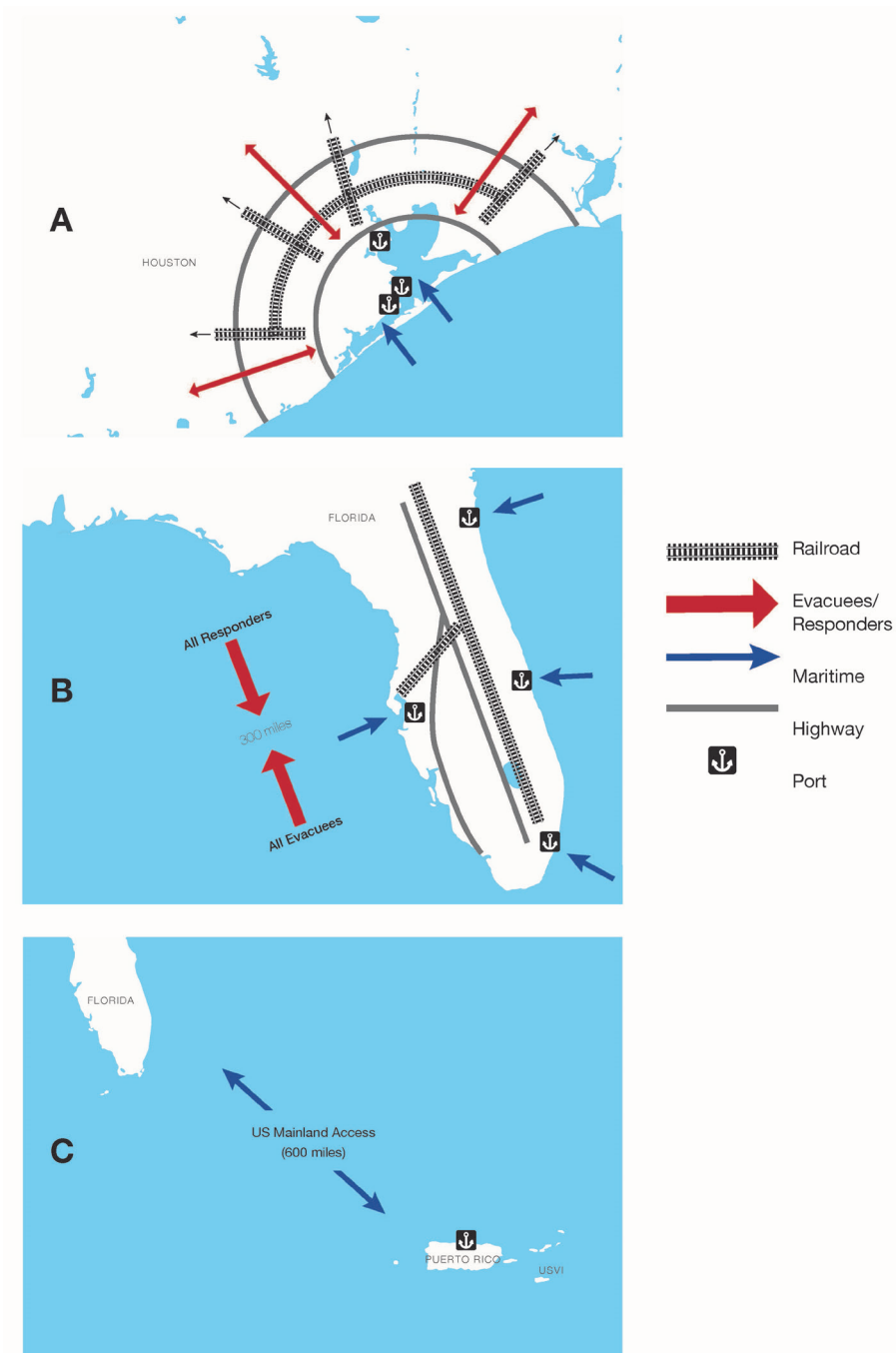

**FIGURE 3.2** Illustration of the different “supply chain geography” context for (a) South Texas, (b) South Florida, and (c) Puerto Rico and the U.S. Virgin Islands.

## STRENGTHENING POST-HURRICANE SUPPLY CHAIN RESILIENCE

geography exacerbates challenges when there is a mass evacuation from vulnerable areas along congested routes or large-scale delivery of critical goods and services into affected areas. Hurricane Irma caused record-breaking rapid evacuations along congested highway routes. Relief supplies can be sourced from U.S. areas outside of the state, but it is still necessary to navigate the peninsula to deliver goods and services, with the uncertainty of being able to return home. Fuel delivery to Florida is primarily by water to port facilities, where it is then distributed by tanker trucks.

- *Puerto Rico and the U.S. Virgin Islands.* These islands rely entirely on delivery of goods and relief supplies by ship and barge, primarily from U.S. ports more than 1,200 miles away. Transit times and delays for delivery of goods are thus an important factor in emergency response planning. Puerto Rico has one large natural harbor (housing the Port of San Juan, a critical node for most supply chains), plus a number of smaller ports located around the island. The island also has mountainous terrain that poses challenges for emergency response and goods delivery. On the island of St. Thomas the main industrial port has very limited space for unloading shipping containers and staging of large-scale relief supply deliveries (which elevates the likelihood of bottlenecks), and there is even less port capacity on the other islands. Evacuation from an island requires considerable advance planning.

### Directional Configuration of the Main Supply Chain Links and Corridors

The most tangible elements of supply chains are physical links such as interstate highways, pipeline routes, and railroad rights-of-way. Development patterns are determined by local geography and by historical economic factors. The levels of redundancy and connectedness are both highly relevant to supply chain resilience.

- *South Texas.* The area has plentiful capacity in terms of multi-modal transport links and corridors, which are highly interconnected and multi-directional.
- *Florida.* The state of Florida is more capacity-limited than South Texas, due to the linear, parallel transport links that predominate along the peninsula.
- *Puerto Rico and the U.S. Virgin Islands.* Puerto Rico is characterized by circumferential routes around the Island's perimeter. The U.S. Virgin Islands are capacity-constrained by a small number of roads on each island. As a result, people living in more isolated inland locations, away from metropolitan centers, often faced far more severe problems with delivery of critical goods.

### Concentration of Critical Nodes and Possible Points of Failure

Links in a supply chain that connect key nodes can often become severe bottlenecks in emergency situations. This is a particular risk where different modes of transportation connect

with one another (e.g., port to truck, port to rail, or pipeline to truck). Capacity constraints on the connecting nodes, and/or a configuration that limits network redundancy, can exacerbate these bottlenecks.

- *South Texas.* Road and rail transport nodes are relatively dispersed, but for maritime transport, the Houston Ship Channel is a critical transportation link and potential single point of failure for a critical distribution network.
- *Florida.* Refined petroleum distribution for a very large market is concentrated at a limited number of fuel racks (an example of critical nodes in the fuel supply chain).
- *Puerto Rico and the U.S. Virgin Islands.* Both settings are significantly constrained by having just a single port of entry for the vast majority of supplies imported to the islands, ports that represent both critical nodes and potential bottlenecks (see Box 3.1).

### Box 3.1

#### Interdependencies Among the Affected Locations

Central to the story of the 2017 hurricane season were the temporal and geographical interdependencies among the affected locations. In terms of temporal overlap, the rapid succession of Hurricanes Harvey, Irma, and Maria meant that governments' and nongovernmental organizations' organizational resources were stretched tremendously thin, as the response focus needed to shift rapidly from Texas to the U.S. Virgin Islands to Florida to Puerto Rico, and again to the Virgin Islands.

Equally important were the geographical/logistical interdependencies among supply chains of the U.S. Virgin Islands, Puerto Rico, and Florida. Close to 80 percent of the normal supply chain for food and consumer goods received by Puerto Rico and the U.S. Virgin Islands coming from the U.S. mainland is transported through Florida. Most commonly, goods are routed through the Port of Jacksonville to Puerto Rico (Port of San Juan), then to St. Thomas, then to St. John and St. Croix. While Irma did not cause significant damage to the Jacksonville port directly, truck deliveries and availability were disrupted throughout Florida and just beginning to return to normal when Maria struck. Marine carriers operating between the United States and Puerto Rico faced disruptions for the entire month of September.

Emergency managers faced many complicated decisions about the routing of relief supplies among the affected locations. When Irma hit the U.S. Virgin Islands and then Florida, emergency relief supplies from the mainland were directed largely at Florida; however, Florida's ability to support the downstream supply was compromised. At the same time, immediately after Irma struck St. Thomas and St. John, they were sent relief supplies from Puerto Rico and St. Croix, which led to these locations being particularly vulnerable when struck by Maria two weeks later. The back-to-back timing of Irma and Maria made supply chain recovery of the U.S. Virgin Islands dependent upon, and at times competing with, recovery in Puerto Rico.

While one can never anticipate all possible scenarios, the 2017 experiences illustrate the tremendous importance of understanding the operation of interdependent supply chains and geographical regions as part of comprehensive emergency management planning and training.

## STRENGTHENING POST-HURRICANE SUPPLY CHAIN RESILIENCE

**Modal Diversity Available**

Geography, history, and public and private investments will determine the modes available to serve an area's supply chain needs. Access to multiple modes provides the resilience benefit of redundant routes and services, which help prevent bottlenecks when primary modes are disrupted.

- *South Texas.* The Houston area has a well-developed multimodal infrastructure, including rail, truck, barge, ship, and pipeline options. There is also substantial intermodal connectivity and redundancy.
- *Florida.* Truck transport is by far the dominant mode for most goods, with petroleum products arriving primarily by ship. This is augmented by some limited rail capacity.
- *Puerto Rico and the U.S. Virgin Islands.* Most goods arrive by ship. Within each island only truck-based distribution originating at the port of entry is available.

**Vulnerability of Critical Infrastructure Needed to Support Supply Chain Operation and Continuity**

Energy supplies (especially refined petroleum and electricity) are essential to support the operation of supply chains. Additionally, in today's connected world, telecom and wireless have become necessary to support both supply chain operations and financial transactions.

- *South Texas.* Lessons learned from past storms resulted in the hardening and resilience of many supply systems, driven in large part by concerns about the operating risks of petrochemical industries. For instance, petroleum companies have installed redundant power supplies, relocated communications systems, and elevated control rooms and pump stations.<sup>5</sup> Utility companies have made similar improvements including investments to their electricity systems by installing intelligent sensors that provide real-time situational awareness about the grid (OEDER, 2010).
- *Florida.* The refined fuel distribution system can be subject to bottlenecks and constrained by access to a limited number of port-based receiving facilities and long intra-state transport distances. The state is subject to large swings in seasonal demand due to tourism. On the other hand, power distribution system upgrades and smart grid investments have reduced vulnerabilities of the electric grid, aiding in quicker response and restoration of power (EEI, 2014).
- *Puerto Rico and the U.S. Virgin Islands.* Critical infrastructure is extremely vulnerable, especially with respect to the electric power and communications networks that are old, outmoded, and inaccessible in mountainous areas.

---

<sup>5</sup> See Hurricane Security Operations, Association of Fuel and Petrochemical Manufacturers, <https://www.afpm.org/industries/performance/preparing-disruption>.



### **3.3 COMPARISON OF THE HURRICANE IMPACTS ON SUPPLY CHAINS IN THE FOUR STUDY AREAS**

For the purpose of this study, the committee was asked to “discuss commonalities and differences in how supply chain systems were affected by Hurricanes Harvey, Irma, and Maria in the affected areas of Texas, Florida, Puerto Rico, and the U.S. Virgin Islands” and to “identify and explain crucial interdependencies, supply chain nodes, and disruptions to supply chains in each of the impacted areas that affected response and recovery” (see the Statement of Task in Box 1.1). It is not feasible to capture the thousands of diverse individual incidents and stories that make up any individual storm event, and it was well beyond the committee’s capacity to provide a comprehensive summary of the supply chain impacts that unfolded in each place. Rather, highlighted here are some select examples of impacts that are most pertinent to the focus of this study. Unless otherwise noted, the information presented in this section comes from the CNA investigations (Palin et al., 2018) and from speakers at the committee meetings. (See list of speakers in Appendix A. This information is paraphrased here, and not presented as direct quotes attributed to individual speakers.)

In all of the cases studied, supply chain problems were related to some element of each storm that was unexpected and/or beyond the scale of what government officials and businesses had prepared for. Houston officials were not expecting such massive flooding that cut off most all road transport for days; Florida officials were not expecting a hurricane with a track that affected most of the state and led to the evacuation of 6 million people; Puerto Rico was not expecting a direct hit by a Category 5 hurricane and complete loss of the power grid; and the U.S. Virgin Islands was not expecting to be hit by two major storms in rapid succession. The 2017 hurricane season vividly illustrated that when unprecedented disasters unfold, it is difficult to predict all possible scenarios of impacts. Hence, supply chain resilience is about not only preventing all adverse impacts, but also being ready to respond nimbly when impacts do occur.

Unsurprisingly, each of the four locations faced many supply chain disruptions that were unique to their situations, and a wide variety of differing experiences unfolded across Texas, Florida, Puerto Rico, and the U.S. Virgin Islands. Some of these distinct features are discussed below.

#### **Southeast Texas / Hurricane Harvey**

The city of Houston, Harris County, and surrounding areas have sophisticated systems for disaster preparedness and response, including strong Emergency Operation Center links with many large private sector organizations. Because many critical facilities in the region (e.g., the Port of Houston, fuel refineries) had engaged in a variety of preparedness exercises and had well-developed platforms for sharing information, during Hurricane Harvey they averted some major problems that could have devastated local, regional, and even national supply chains.



*STRENGTHENING POST-HURRICANE SUPPLY CHAIN RESILIENCE**Power and Communications*

Some utilities experienced significant damage to areas northeast of Corpus Christi (AEP Texas, in Port Aransas and Rockport), mostly due to wind, but only about 2.5 percent of customers in Texas experienced power outages, with the majority of customers being restored one week to 10 days after the storm landfall (ISER, 2017). Texas utilities' preparedness efforts and investments in smart grid technologies aided in the rapid response.<sup>6</sup>

*Food and Water Supplies*

Distribution and delivery services for food, bottled water, and other critical goods were interrupted for more than one week, during the time that flooding made road deliveries impossible, but as the waters receded (and high-water trucks were brought in to help with delivery) most grocery stores quickly recovered and reopened. The disruption to municipal water systems (discussed below) led to a surge in demand for bottled water, but pre-positioning of supplies seems to have prevented widespread supply shortages.

One unique aspect of the Hurricane Harvey response is the region's readiness to collect and distribute food aid through an extensive network of food banks and community-sponsored or operated points of distribution; a network that essentially operated as its own supply chain, under the Emergency Food and Shelter Program.<sup>7</sup> More than 40 trailers of food and supplies were collected and distributed through this system to cover local needs in the first days after the event.<sup>8</sup>

As Harvey's flooding increased, many parts of the municipal water system in the region failed with little notice. More than 1 million people in the region had their water service temporarily affected, and some remained on boil-water advisories for more than three weeks. Many unforeseen complications hindered efforts to repair the system, and this had cascading impacts across numerous critical facilities (e.g., hospitals unable to operate). Due to help from regional peer utilities and the Texas Department of Emergency Management, however, little federal assistance for system repair and restoration was ultimately needed.

*Fuel Supplies*

Texas and Louisiana are major fuel-producing hubs that supply the local region as well as many other regions, primarily along the east coast. Therefore, any sustained closure or damage at these facilities can have widespread impacts on supply chains, involving numerous critical production nodes and transportation links in the fuel supply chain. During and

---

<sup>6</sup> See testimony by DeAnn Walker, Public Utility Commission of Texas (Walker, 2017).

<sup>7</sup> See <https://www.fema.gov/media-library-data/1532523209760.4943fdee1432ba47de17e2a9c5357502/mergencyFood.pdf>.

<sup>8</sup> See <https://www.citylab.com/environment/2017/09/houston-food-storm/538521/>.

immediately after Hurricane Harvey struck, most major facilities were closed for some period of time. For instance, there was closure of all major ports along the Texas coastline (Sector Corpus Christi, Sector Houston/Galveston, Sector Port Arthur/Lake Charles), of approximately 25 percent of Gulf Coast offshore oil and natural gas production, and of approximately 50 percent of Gulf Coast refinery capacity,<sup>9</sup> as well as some major marine terminals and crude and product pipelines (Colonial, Explorer, Magellan).

While the state of Texas issued emergency evacuation orders prior to the storm, Houston and Galveston did not.<sup>10</sup> After the storm, local fuel-distribution facilities and retail fuel stations did experience temporary fuel shortages due to increased demand, driven largely by public fear of gas shortages<sup>11</sup> as well as some flooding-related delivery problems. However, major pressures on this supply chain were alleviated by the lack of major evacuations, the limited power outages, and the fact that most critical nodes had a high inventory of fuel supply when the storm hit.

### *Medical and Pharmaceutical Supplies*

Medical supply chain systems and local care coalitions were relatively well-prepared and ready to function when needed. Pharmaceutical manufacturers and distributors in the region remained mostly stable. Closure of the airport caused some disruptions, but because there was a surge of products into the region before the storm, no major shortfalls resulted. Officials from the Department of Health and Human Services and the Office of the Assistant Secretary for Preparedness and Response helped to ensure that hospitals had what they needed.

As with other supply chains, flooding caused the greatest challenges in the delivery of medical and drug supplies and maintaining the population's access to medical care. For instance, the Hospital Corporation of America's health care network (discussed in the Florida section) had extensive disaster preparedness plans, yet the massive flooding led to major difficulties in delivering supplies to medical facilities. Some other challenges included:

- re-entry and credentialing issues that arose due to lack of clear procedures;
- getting supply deliveries to home health care providers, again largely due to the flooding of roads; and
- insufficient understanding of which critical infrastructure facilities (especially water treatment plants and power plants) provide service to which hospitals and other health facilities, meaning that the operators of a given facility did not know whether the shutdown of a particular water treatment or power plant would affect them.

---

<sup>9</sup> See [https://www.bakerobrien.com/bakerobrien3/assets/File/BakerObrien\\_com - After the Storm - Part 1.pdf](https://www.bakerobrien.com/bakerobrien3/assets/File/BakerObrien_com_-_After_the_Storm_-_Part_1.pdf).

<sup>10</sup> See <https://law.utexas.edu/news/2018/09/14/the-cost-of-emergency-evacuation/>.

<sup>11</sup> For example, <https://patch.com/texas/downtownaustin/hurricane-harvey-social-driven-panic-leads-mad-rush-gasoline-texas>.

*STRENGTHENING POST-HURRICANE SUPPLY CHAIN RESILIENCE*

Supply chains in the South Texas region proved largely flexible and resilient during Hurricane Harvey, but the event illustrated that even the most prepared organizations and systems will have great difficulties functioning when flooding is too severe and when critical infrastructure (e.g., municipal water supplies) is damaged. This suggests that for this region, priorities for building resilience are investments to advance more sustainable development patterns that minimize flooding problems (e.g., to elevate critical roadways and to minimize impervious surfaces) and preparedness efforts to mitigate vulnerabilities in infrastructure that can affect multiple supply chain nodes.

**Florida / Hurricane Irma**

With a long history of hurricane landfalls, Florida has well-organized systems for disaster preparedness and response. This includes a strong Emergency Operations Center with extensive networks of relationships among emergency management officials at state, county, and local levels together with representatives of industry groups responsible for maintaining the flow of critical goods and services (e.g., the Food Marketing Institute, the Florida Petroleum Council, the American Fuel and Petrochemical Manufacturers), integrated via the state's Business Emergency Operations Center. This foundation helped prevent many adverse outcomes that could have otherwise occurred during Hurricane Irma. Yet Irma illustrated some important limitations and vulnerabilities of current systems, for instance, in terms of:

- meeting fuel demand in the face of a massive evacuation that caused demand spikes across the state;
- maintaining a sufficient inflow of supplies despite serious transportation bottlenecks caused by fuel limitations, traffic backups, and lengthy deadheading<sup>12</sup> return trips; and
- ensuring adequate coordination in the movement of trucks and supplies across state lines, in the face of information disruptions and communication problems.

Compared to the large, highly populated counties such as Miami-Dade and Broward, less populated counties such as Collier and Monroe (which includes the Florida Keys) have few emergency management staff members and much less private sector engagement. Representatives from these areas (at the committee's meeting in Florida) noted their heavy dependence on state resources for disaster response and their struggles with onerous FEMA procurement regulations (including limitations on purchasing supplies locally), as well as long wait times for reimbursement of expenditures.

---

<sup>12</sup> The term "deadheading" refers to trips made by truckers pulling an empty trailer with no cargo, thus generating no revenue.

### *Power and Communications*

Power outages were widespread across Florida during Hurricane Irma. At its peak, approximately 60 percent of Florida customers were without power.<sup>13</sup> Twelve counties had 90 percent or more of electricity customers without power. However, power was restored to most customers relatively quickly. Worse problems were avoided largely thanks to preparedness efforts that had been implemented over the preceding decade, in which Florida Power & Light and other investor-owned utilities in the state made significant investments to upgrade power system infrastructure and deploy smart grid technologies that provided timelier, more accurate information about outages.<sup>14</sup> Florida officials also noted that the state designates electric utilities as first responders and coordinates with the investor-owned utilities prior to a major storm to pre-stage fuel across the state, which facilitates the restoration of power.

### *Food and Water Supplies*

Preparedness strategies of large retailers and “big box” stores (e.g., Publix, BJ’s) allowed for substantial advance stockpiling of food and bottled water, and made possible the use of generators during power outages. Therefore, storm-related shutdowns of most grocery stores lasted for only a few days. Staffing shortages were one of the more significant challenges, as many workers had evacuated or had to care for others. Hurricane Irma caused breaks in water mains, which led to boil-water orders in four counties, driving a surge in demand for bottled water and ice in impacted areas. Grocery chain Publix reported having a large stockpile of bottled water and ice, and yet could not keep up with demand.

### *Fuel Supplies*

Florida has almost no fuel production facilities in state; rather, it receives the bulk of fuel from the Gulf Coast region and foreign imports. When Irma approached, there was temporary closure of most major Florida ports (Miami, Key West, St. Petersburg, Port Everglades, Jacksonville, and Pensacola), the Kinder-Morgan petroleum pipeline, and major petroleum marine terminals. However, such closures were short-lived and thus did not themselves cause any major supply problems. During disasters, the state of Florida sets up fuel-staging depots for first responders; public and private utilities are allowed access to the fuel depots to aid in quicker response and restoration of power.

An array of fuel problems did arise, however, stemming initially from the evacuation of more than 6 million people and the resulting surge in fuel demand, which caused bottlenecks at many fuel stations. This surging demand at retail stations was exacerbated by re-supply

---

<sup>13</sup> See <https://www.energy.gov/ceser/downloads/hurricanes-nate-maria-irma-and-harvey-situation-reports>.

<sup>14</sup> See <https://www.eia.gov/todayinenergy/detail.php?id=32992>.

*STRENGTHENING POST-HURRICANE SUPPLY CHAIN RESILIENCE*

bottlenecks resulting in part from long wait times for refueling tanker trucks at petroleum loading racks. Factors such as limited rack space and contractual allocation limitations on fuel withdrawals<sup>15</sup> contributed to the bottlenecks and attendant delays at retail fueling stations.

As the storm struck, bottlenecks at retail gas stations were further aggravated by power outages, flooding, and staff shortages, as well as the inability of some smaller stations to obtain banking credit to keep pace with the fuel demand surge. This all forced a prolonged closure of many retail gas stations, including facilities located at critical spots along evacuation routes. There was also a short-term surge in demand for diesel fuel after the storm, related to the use of generators, debris removal, and vehicle equipment used for restoration and recovery efforts.

*Medical and Pharmaceutical Supplies*

There were few major problems reported in the delivery of medical and pharmaceutical supplies in Florida after Hurricane Irma, in part because many Florida-based medical and pharmaceutical supply companies have robust continuity plans in place. For instance, some companies pre-positioned pallets of critical supplies at area hospitals and had systems to access their warehouse supplies in the absence of power. The Hospital Corporation of America manages a network of more than 200 hospitals and has a sophisticated Enterprise Preparedness and Emergency Operations system that includes real-time situational awareness dashboards and asset trackers; systems to pull staff from across state borders and to provide mass transportation services (including helicopters) to mobilize supplies and staff; and 60 warehouses to stockpile supplies. Some of the supply and distribution challenges that did arise included the following:

- Small nursing homes, hospice, and home care providers often were lacking back-up power,<sup>16</sup> and they were particularly vulnerable to supply shortages, as they could not stockpile many supplies and often had only one provider to service them.<sup>17</sup>
- Onerous procurement regulations prevented local emergency managers from requisitioning supplies from nearby stores and distribution centers.
- In the absence of electricity, pharmacists could not submit electronic forms for releasing controlled substances.
- Coordination challenges related to re-entry procedures arose for medical-industry personnel.

---

<sup>15</sup> See discussion of issues related to fuel contracts in Box 4.4.

<sup>16</sup> See <https://www.usnews.com/news/best-states/florida/articles/2018-06-02/agency-most-florida-nursing-homes-without-backup-power>.

<sup>17</sup> Florida now requires that nursing homes have back-up generators with at least a 96-hour fuel supply. For more information, see [https://ahca.myflorida.com/MCHQ/Emergency\\_Activities/EPP.shtml](https://ahca.myflorida.com/MCHQ/Emergency_Activities/EPP.shtml).

- There was limited understanding by federal emergency managers of local medical supply producers and distributors that needed to be prioritized for support, leading to misallocation of capacity and supplies.
- Key federal officials in the Department of Health and Human Services had insufficient information about drug manufacturers in the region (e.g., the location, capabilities, and criticality for national supply chains), which impeded strategic decisions about which facilities to prioritize for operational assistance.

### **Puerto Rico / Hurricanes Irma and Maria**

Compared to the other locations examined, Puerto Rico faced some fundamental vulnerabilities that underlay how the 2017 hurricanes affected the island. This included:

- significant limitations in the coordination of emergency preparedness systems, stemming from insufficient communication among federal and local agencies, and lack of trust and partnership between government and the private sector;
- the failure of fragile and aging (and thus vulnerable) electric power and communications infrastructure, leading to a host of cascading impacts (e.g., hindering emergency response efforts, disrupting the ability to process electronic payments in stores);
- limited understanding by government officials of the island's critical supply chains and a lack of capacity for assessing the status of those systems in the aftermath of the storm, leading to many inaccurate assumptions about what response efforts were most needed; and
- multiple hurricanes in quick succession diminishing FEMA's response capacity by the time Maria struck and also exacerbating bottlenecks across many supply chains.

Many of the post-hurricane supply chain challenges that arose in Puerto Rico centered around the Port of San Juan. Cargo was able to make it to the port, but due to the sustained power outage, goods coming in could not be processed effectively, and due to blocked roads and shortages of trucks and drivers, many goods could not be removed from the port area. The port thus quickly became overwhelmed as large loads of relief supplies poured in. Related problems stemmed from the fact that many arriving relief shipments had little or no descriptive labelling, which further slowed processing steps. Disaster relief shipments also displaced shipments of other goods that were crucial for restoration of the island's normal supply chains (see, for example, the bottled water discussion below).

#### *Power and Communications*

The power infrastructure in Puerto Rico was fragile even during normal times, with power plants located in the south of the island and the main consumption in the north. Power lines

*STRENGTHENING POST-HURRICANE SUPPLY CHAIN RESILIENCE*

(about 75 percent of them aerial) had to cross over the mountains, with a significant loss of energy during transmission. The grid had no redundancy; therefore, even with only limited damage, significant portions of the grid could go down. Hurricane Irma led to power outages for more than 55 percent of utility customers, and Hurricane Maria led to an almost complete failure of the electricity transmission system, with 100 percent of customers losing power. Restoring power was a complex, controversial process that took many months to complete.

*Food and Water Supplies*

In the aftermath of Hurricane Maria many communities in Puerto Rico faced major food shortages and thus initially were heavily dependent on relief supplies.<sup>18</sup> At the same time, however, many grocery stores across the island proved quite resilient and were able to re-open within a few days after the storm. Even well after resumption of normal food distribution and re-opening of grocery stores, FEMA continued to receive and fill requests for food aid (in the form of “meals ready to eat”), and as this meal distribution continued, it raised concerns that people were stockpiling excess “meals ready to eat” and local commerce was being undermined. Grocery stores were also adversely impacted when truckers were lured away from their normal jobs to run relief supplies or wait at the port. Perhaps of greatest impact, however, was the fact that sustained power and communication outages meant no processing of electronic payments (including the electronic benefits transfer system that many people depend on to buy food), along with constraints in obtaining cash from automated teller machines. Therefore, many people had no means of buying food even when shelves were stocked.

Potable drinking water services on the island were disrupted for an extended period of time (more than three months), driving an ongoing need for bottled water. FEMA stockpiled huge quantities of bottled water at the Port of San Juan, but much of this did not get distributed.<sup>19</sup> Meanwhile, Puerto Rico’s local water-bottling facilities remained idle for an extended time after the storm because the containers holding the raw materials needed for the bottling process (resin for bottle caps) were not considered a high priority and were not released from the port, while relief shipments of bottled water continued to flow in—thus prolonging the island’s dependence on imported relief supplies.

*Fuel Supplies*

All of Puerto Rico’s fuel is imported to the islands from the Atlantic and Caribbean basins. During Hurricane Maria, petroleum terminals were shut down and retail fuel stations were temporarily closed, but there were no reports of serious shortages of gasoline supply on the island. The main problems were related to fuel distribution, including the power outages that prohibited the processing of some fuel shipments, a lack of truck drivers, and the need

---

<sup>18</sup> See <https://www.theguardian.com/world/2017/oct/11/puerto-rico-food-shortage-hurricane-maria>.

<sup>19</sup> See <https://www.cnn.com/2018/09/12/us/puerto-rico-bottled-water-dump-weir/index.html>.



for security escorts for the tankers that were able to deliver. Gas stations' inability to use electronic commerce (i.e., credit and debit cards) posed further problems and security concerns, as many had to purchase fuel supplies with large sums of cash, and customers could only pay in cash as well.

Because Puerto Rico's residents were without power for sustained periods of time, there was a heavy reliance on generators. While a significant percentage of households and facilities across the island did have generators, many had not been maintained, and stocks of generator fuel were scarce, which led to a cascade of problems for many critical facilities (e.g., hospitals, manufacturing plants, and grocery stores). There was little clarity regarding how FEMA and other officials made decisions regarding what public facilities received generator and diesel fuel aid, and regarding how to provide such support for private sector entities with important roles in providing critical resources.

As one positive example of preparedness—the island's propane and liquified petroleum gas supply and distribution proved resilient, largely because the island's largest supplier (Empire Gas) was well prepared to sustain the operations of its delivery terminal, storage facilities, truck fleets, and networks of drivers.

### *Medical and Pharmaceutical Supplies*

Puerto Rico is a hub of manufacturing for a range of pharmaceuticals and medical goods, with at least 40 manufacturing facilities, 13 of which produce drugs that have no other supplier. For instance, Baxter operates three large manufacturing facilities in Puerto Rico that produce sterile saline solutions (i.e., intravenous fluids) for most of the United States. After Hurricane Maria, all of the Baxter facilities lost power and reduced production to what could be achieved with generators. In October 2017, the Food and Drug Administration urged FEMA, Puerto Rico's governor, and the Puerto Rico Electric Power Authority to prioritize power restoration to these facilities; however, the national importance (criticality) of these facilities was not completely understood, and it took until early January 2018 to return them to full operation. This disruption caused supply chain effects that cascaded to the mainland United States and around the world. While many of Puerto Rico's individual pharmaceutical industry plants had substantial preparedness and continuity plans, these critical nodes in pharmaceutical supply chains were still vulnerable to the sustained, island-wide power loss. There was also a wide variety of challenges that arose in providing medical goods and services to residents on the island in the days and weeks after the storms hit. Some examples noted in the committee's meetings were:

- confusion about who was responsible for meeting needs or providing assistance (including power restoration and generator fuel assistance) for private hospitals, medical facilities, and dialysis centers;
- problems with supply and distribution of medical oxygen, which could not be produced locally due to lack of power and which faced many barriers in being



## STRENGTHENING POST-HURRICANE SUPPLY CHAIN RESILIENCE

shipped to the island (an example of a critical supply chain with predictable vulnerable nodes); and

- confusion over local curfews, which created an artificial bottleneck that impeded the ability to distribute medical supplies.

### **U.S. Virgin Islands / Hurricanes Irma and Maria**

The U.S. Virgin Islands were tremendously affected by Hurricanes Irma and Maria (USVI HRRTF, 2018).<sup>20</sup> Some of their challenges were similar to those in Puerto Rico, for instance, in terms of being almost entirely dependent on ship and barge imports for food, fuel, medicine, and other critical goods; limited emergency management resources; and aging, fragile infrastructure. The U.S. Virgin Islands also faced some unique challenges, such as the complexity meeting the needs of affected populations on three different islands; difficulties in finding means to dispose of post-storm debris; and very limited options for housing for relief workers along with displaced residents (USVI HRRTF, 2018).

Despite these challenges, the conveyance of some critical relief supplies by FEMA and others operated relatively efficiently, at least relative to the problems that arose in Puerto Rico. This is partly because the scale of the population being served was much smaller, with fewer communities isolated by onerous terrain. The main port for the U.S. Virgin Islands, on the island of St. Thomas, is relatively small, with little space or equipment (e.g., forklifts, trucks) for receiving, storing, and processing relief goods. On St. John and St. Croix such constraints were even more acute. This led to some competition for resources between relief supply chains and regular commercial supply chains at certain points in the response process. There were also problems with relief supplies arriving with no clear inventory or labeling, and shortages of workers, given that essentially everyone on the island was a storm victim.

One concern noted by meeting participants was how efforts to proceed in repairing and rebuilding damaged structures were hampered when relief supplies such as tarps and water bottles were given priority for shipment over cement and other construction materials. It took many months for the main hardware store on St. Thomas (Home Depot) to re-open and restock, although, fortunately, two other smaller hardware stores on the island (MSI, SeaChest) were well prepared with advance stocking of key inventory and facilities that withstood major storm damage.

Despite the tremendous destruction of the two storms, there were many signs of resilience among the local population. Most island businesses re-opened quickly; most island roads were cleared with help from residents; and many homes and facilities had working generators, fuel, and other emergency supplies, as well as cisterns to collect

---

<sup>20</sup> Many of the impact details in this section came from the report of the U.S. Virgin Islands Hurricane Recovery and Resilience Task Force (USVI HRRTF, 2018).

water (discussed below). On St. Croix, a coalition of nonprofit organizations that had recently formed to advance community preparedness provided crucial aid for many people immediately after the storm. Local community centers were a lifeline in supporting residents, especially in isolated areas. Improvised partnerships with a local AM radio station provided crucial post-storm communication aid for people trying to find missing persons or share important safety information.

### *Power and Communications*

The two hurricanes caused almost complete disruption to the U.S. Virgin Islands' power systems. During Hurricane Irma, the power grid was badly damaged and went down on the islands of St. Thomas and St. John. And St. Croix lost all power during Hurricane Maria. In many places, the outages lasted for more than four months. There were challenges obtaining raw materials and parts from the mainland for repairing the grid, and more than 800 linemen were brought in from off-island to aid the restoration efforts. As happened elsewhere, these power outages had many cascading impacts on the ability to resume normal commerce and other operations across the islands. Some wind and solar power generation on the islands survived, illustrating how distributed energy systems can reduce vulnerability.

Many places were equipped with back-up generators, but many of these eventually failed because they were not designed to run continuously for months; obtaining generator fuel over this extended time period was also a challenge. Critical public sector facilities such as airports and hospitals received generator assistance (from the Army Corps of Engineers, FEMA, the Virgin Islands Territorial Emergency Management Agency), but privately owned critical facilities (such as radio stations and private cell phone towers) were not eligible to receive generators and thus could not get back online.

The island's communications infrastructure (cell service, broadcast radio, Internet) was severely disabled. Damage to cell towers meant loss of around 80 percent of cell service on St. Thomas and St. Croix and 100 percent on St. John. Full restoration required bringing in off-island personnel and took several months.

### *Food and Water Supplies*

Nearly all facilities for the production and delivery of potable water across the U.S. Virgin Islands were affected by direct damage and/or the power outages, and full restoration of the system took roughly a month. Fortunately, almost all households in the U.S. Virgin Islands are equipped with cisterns to collect rainwater for household water use. This adaptation, driven largely by the limited groundwater options and relatively recent development of municipal water systems, greatly alleviated water stresses in the aftermath of the storms. At the same time, however, most residents use bottled water for drinking, so there was continued high demand for bottled water following the storms.

## STRENGTHENING POST-HURRICANE SUPPLY CHAIN RESILIENCE

Following both storms, grocery stores were closed, but only for a few days. There were no wide-scale reports of food shortages, but the power and communication outages meant that residents faced real challenges paying for store purchases, given the lack of access to cash withdrawal or to electronic commerce (i.e., Electronic Benefit Transfer (EBT) and debit/credit cards). The limited curfew hours imposed on residents, coupled with damaged and congested roads, made it difficult for many residents to simply find time to gather needed daily supplies. The storms also raised new concerns about the U.S. Virgin Islands' total dependence on imports for food, which lowers costs (relative to local food production) but increases supply chain vulnerabilities.

### *Fuel Supplies*

During the emergency response and recovery period, gas stations established a rule that each individual could purchase only as much gasoline they could carry, which helped prevent hoarding and alleviate bottlenecks that would have caused fuel shortages. Some fuel distribution problems arose, in part because fuel racks were not powered for a period of time and because (unlike places such as Florida),<sup>21</sup> the U.S. Virgin Islands has no requirements that retail gas stations have generators or are generator-ready.

### *Medical and Pharmaceutical Supplies*

There was major damage to the U.S. Virgin Islands' hospitals and other critical health facilities, and power outages meant prolonged closure of many pharmacies lacking generators. The islands' longstanding problems with insufficient numbers of medical personnel were exacerbated when many left the islands after the hurricanes due to destroyed homes, family safety needs, etc. Another major challenge was that the great majority of the U.S. Virgin Islands' medical supply distributors are in Puerto Rico, and because those companies were themselves dealing with hurricane impacts, they could not maintain normal shipments. Some medical supplies were also delayed in Puerto Rico because the boxes were not marked as "critical" until FEMA stepped in to help get them labeled as priority (an example of an information failure that created an artificial bottleneck in a critical supply chain).

As a result of these and other constraints, medical and pharmaceutical services across the U.S. Virgin Islands experienced many difficulties in the aftermath of the storms. The U.S. Virgin Islands Department of Human Services faced many coordination challenges such as the following:

- problems gathering needed data from the Red Cross and other territorial public agencies, and operational silos that limited coordination among federal agencies (including FEMA, see FEMA (2018a)), local government agencies, companies, and nongovernmental organizations;

<sup>21</sup> It is the law in Florida that retail gas stations within one-mile of an evacuation route have a generator hook-up.

- little pre-positioning of essential medication stocks for the islands<sup>22</sup> and lack of coordination in distributing available drugs and determining who was permitted to write prescriptions;
- problems of donated pharmaceuticals having no documented source, which local pharmacists did not feel comfortable dispensing; and
- mismatches between the medical supplies needed and those provided by federal aid programs (e.g., regarding specific types of insulin needed versus received).

Eventually the arrival of mutual aid support medical teams (i.e., human and material resource assistance coming from across jurisdictional boundaries) alleviated some of these problems.

### **Common Features and Lessons Learned from the 2017 Experiences**

Even with the diverse contexts and experiences of the different storm-affected areas, some of the dynamics that unfolded—both pre- and post-hurricane—were common across each of the places considered, pointing to important lessons to consider moving forward.

- Post-hurricane bottlenecks and disruptions arose more frequently at the distribution level than at the production level. This is in part simply because distribution occurs within the affected region, while (in many cases) much of the production occurs elsewhere. But in addition, this is because distribution is often carried out by businesses and organizations with less preparedness capacity than large companies have (discussed below).
- Some of the most common factors underlying these “last mile” distribution challenges were shortages of trucks and drivers for goods delivery, other personnel shortages that occurred when workers themselves became storm victims, and damage to critical infrastructure that impeded the distribution and selling of goods. Another common source of bottlenecks at the distribution level was unsolicited donations sent to affected areas, which drew critical resources away from more strategically targeted needs (see Box 3.2).
- Many large companies had invested in continuity planning, partnerships with government officials, employee assistance programs, and resources to harden and back up critical systems. Comparatively, small businesses (e.g., locally owned groceries and convenience stores, home health care providers) generally had much less capacity to prepare for and avoid supply chain disruptions.

---

<sup>22</sup> Most pharmacies in the U.S. Virgin Islands are family-owned rather than national chains—and this limits their ability to stockpile certain critical drugs because of restrictions in returning unsold merchandise.

## STRENGTHENING POST-HURRICANE SUPPLY CHAIN RESILIENCE

**Box 3.2****Unsolicited and Undesignated Donated Commodities**

A challenge often arising in the wake of a disaster is that affected communities are overwhelmed with unsolicited donated commodities. Well-meaning individuals or organizations often collect supplies (e.g., bottled water, diapers and formula, food, clothing, toys, even medicines and pharmaceutical supplies) and transport them into a disaster area without necessarily having a confirmed recipient or demand signal. Although the intention behind these donations is noble, they often create more problems than they solve by pushing non-critical products into a supply chain that is already under tremendous strain.<sup>a</sup>

One concern is that a large influx of free items can undermine local sales of similar products, and thus can actually slow an area's economic recovery. Another concern is that donations are often packaged generically as "disaster relief," so organizations receiving the donations are unaware of the specific contents of the donation.

In the best case, donors find an organization in the disaster area willing to accept their donation, and the supplies eventually make it to disaster survivors. Yet in these cases, significant staffing and resources are still required to sort and repack those donations, to move the materials to warehouses, and to complete the "last mile" of delivery. These processes can pull away critical assets and resources—people, such as truck drivers or warehouse workers, and things, such as dry storage space—from more strategic disaster response efforts. The worst-case scenario for these donations is that donors are unable to locate an organization willing to accept the goods and so they simply dump the items in a parking lot or beside a roadway. This leads to a debris management issue for the affected jurisdiction.

These problems are fueled in part by the tone of media coverage, which tends to focus on the most dramatic destruction and disruptions occurring (not on successful efforts to meet local needs) and on celebrating "heroic" efforts of organizations that fill trucks with supplies.<sup>b</sup> Rapid dissemination of social media posts leads to broad propagation of appeals. Yet often in such cases, the need for which the original appeal was posted is rapidly filled, but "turning off the spigot" is difficult, and supplies continue to flow in. This was the case after Hurricane Maria, where former Puerto Rico residents in the continental United States, urged on by messaging from celebrities and an appeal from the Puerto Rico Federal Affairs Administration, collected more than 50 million pounds of supplies (possibly much more, if one includes donations sent directly by parcel)—far more than could be handled.

- Vulnerable infrastructure, especially for power and communications, is a predictable vulnerability, and the speed with which supply chains can recover often heavily depends on the resilience of this infrastructure. In places where there was investment in reducing vulnerabilities (especially for hardening electric power systems), benefits are seen in terms of minimizing storm disruptions and thus bolstering the speed with which local economies could resume normal operations (see Box 3.3). Emergency managers' ability to understand post-storm supply chain bottlenecks was constrained by limited pre-storm assessment of vulnerable and critical supply chain nodes, together with information disruptions resulting from power and communication loss. This in

The CNA analysis on which this report draws explores how communities in the Coastal Bend area of Texas were overwhelmed with truckloads of unsolicited donations following Hurricane Harvey. Finding dry spaces to sort and store all these materials became a huge burden on emergency response managers and volunteers. Trucks arriving with no clear delivery destination clogged roads, used scarce fuel supplies, and dumped supplies in random locations. In the hot humid conditions, many of the donations became moldy and thus hazardous. Some relief workers called the disruptive onslaught of unneeded goods “the second disaster.”

There is growing research into this problem; for instance, Holguín-Veras et al. (2014a) explore the challenges created by post-disaster “material convergence,” and suggest management and control strategies. The following statement issued by Texas officials in the wake of Hurricane Harvey offers an example of effective messaging:

The State of Texas is asking that you please DO NOT donate unsolicited goods such as used clothing, miscellaneous household items, medicine, or perishable foodstuffs at this time. As we continue to receive unsolicited donations, supporting agencies must redirect staff and volunteers away from providing direct services to survivors in order to sort, package, transport, warehouse, and distribute items that may not meet the needs of disaster survivors. The most effective way for individuals and private sector partners to support disaster survivors in their recovery is to donate money and time to trusted, reputable, voluntary or charitable organizations. Cash donations offer voluntary agencies and faith-based organizations the most flexibility to address urgently developing needs, as well as needs that arise over the coming months and years. With cash in hand, these organizations can obtain needed resources locally which will help local economies recover.<sup>c</sup>

<sup>a</sup> For example, <https://www.cbsnews.com/news/best-intentions-when-disaster-relief-brings-anything-but-relief/>.

<sup>b</sup> For example, <http://www.fox5atlanta.com/news/atlanta-area-businesses-collect-items-for-puerto-rico>.

<sup>c</sup> See TXVOAD and the OneStar Foundation, <http://cms5.revize.com/revize/seguintx/Fire%20Department/Volunteer%20&%20Donation%20Messaging%20-%209.3.17.pdf>.

turn limited their ability to make optimal decisions about prioritizing the allocation of relief supplies and to know when to stop the push of relief supplies into an area.

- There was often confusion regarding the priorities and practices of FEMA and other emergency management officials for providing generators and fuel to parties in need of assistance—in particular priorities and practices around supporting private entities that are critical nodes in local or national supply chains.

These concepts are discussed further in the following chapter, and they underlie the committee’s recommended actions and resilience strategies.

## STRENGTHENING POST-HURRICANE SUPPLY CHAIN RESILIENCE

**Box 3.3****Comparison of Power Loss and Restoration Among the Four Locations**

The 2017 hurricanes damaged numerous types of critical infrastructure, but official data tracking the impacts can be difficult to find for most sectors. Two metrics that can be tracked relatively well, however, are electricity outages and restoration times, as these are reported by utilities to the Department of Energy (DOE), and during disasters, DOE prepares daily situation reports. Such information allows for direct comparison of impacts among the different focal areas for this study (see table below). These electricity outage and restoration numbers can provide a useful general indicator of impacts to other sectors—including many critical supply chains—given the fact that most commerce and most other key lifeline infrastructure are heavily dependent upon the availability of electric power.

| Location                         | Peak Power Loss<br>(% of residential customers affected;<br>total # of utility customers) | Length of Time for Restoration<br>(to the majority of customers who<br>could receive power) |
|----------------------------------|---|---|
| Texas <sup>a</sup>               | 2.5% [~306,000]   | ~11 days  |
| Florida <sup>b</sup>             | ~60% [~6.1 million]   | ~13 days  |
| Puerto Rico <sup>c</sup>         | 100% [~1.6 million]   | ~7 months   |
| U.S. Virgin Islands <sup>d</sup> | 100% [~45,000]  | ~4 months   |

<sup>a</sup> DOE stopped reporting Texas outages on September 6, 2017, with 1 percent of the customers remaining without power. Testimony from DeAnn Walker, Public Utility Commission of Texas, indicated that 100 percent restoration occurred by September 14, 2017 (Walker, 2017).

<sup>b</sup> DOE stopped reporting Florida outage data on September 24, 2017, with approximately 7,800 Florida customers remaining without power.

<sup>c</sup> DOE reported on April 8, 2018, that 96 percent of customers' power had been restored, although complete restoration of power took several months longer (e.g., see: <https://www.vox.com/identities/2018/8/15/17692414/puerto-rico-power-electricity-restored-hurricane-maria>).

<sup>d</sup> DOE stopped reporting on the U.S. Virgin Islands on January 31, 2018, noting that approximately 7 percent of customers remained without power. According to the U.S. Virgin Islands Hurricane Task Force, greater than 90 percent of customers were restored by the end of December.

Source: U.S. Department of Energy Hurricane situation reports, found at <https://www.energy.gov/ceser/downloads/hurricanes-nate-maria-irma-and-harvey-situation-reports>.

## 4

## Strategies to Foster More Effective Conveyance and Distribution of Critical Relief and Recovery Supplies

The committee's Statement of Task calls for "options and recommendations for future effective conveyance and distribution of food, fuel, medical supplies, water, and pharmaceuticals during disaster response and recovery operations" (see Box 1.1). In addressing this, the committee looked across the many observations, examples, and lessons learned from the three 2017 hurricanes (including the site visits and meeting presentations by local representatives) and drew upon committee members' own diverse experiences dealing with many types of disasters and emergencies. This chapter outlines four overarching recommendations for advancing our nation's capacity to provide critical supplies to affected populations in the aftermath of hurricanes:

- 4.1. Shift the focus from pushing relief supplies to ensuring that regular supply chains are restored as rapidly as possible through strategic interventions.
- 4.2. Build system-level understanding of supply chain dynamics as a foundation for effective decision support.
- 4.3. Support mechanisms for coordination, information sharing, and preparedness among supply chain stakeholders.
- 4.4. Develop and administer training on supply chain dynamics and best practices for private-public partnerships that enhance supply chain resilience.

These recommendations are explored in the following sections, in some cases illustrated by specific examples from the 2017 hurricane season. Additionally, the committee offers specific suggestions in addressing each recommendation.



*STRENGTHENING POST-HURRICANE SUPPLY CHAIN RESILIENCE***4.1 SHIFTING THE FOCUS**

In the run-up to an impending event such as a hurricane, government officials and others will encourage people to prepare by stocking up on items such as food, water, medicine, and batteries. Normal supply chains prepare to handle the surges of demand and projected shortages due to an anticipated disruption. For instance, retail stores ramp up deliveries of bread, milk, water, batteries, and cleaning products in advance of a hurricane because they know that consumers will stock up on emergency supplies before the storm hits. At the same time, as a hurricane approaches, government and relief agencies also begin to assemble stockpiles of food, water, and other essential supplies for distribution in the aftermath of the storm. These competing demands can quickly outstrip the supply of resources.

Immediately following the storm, commercial supply chains can be disrupted because inbound shipments of restocking material may be delayed and critical infrastructure may be damaged. Supply chain managers often take these variables into account and have contingency plans to fill the gaps and get products back on the shelves. In many cases, these plans are sufficient and stores are brought back to pre-disaster conditions quickly, and government intervention is not required. But if a disaster overwhelms local resources and normal commercial supply chains are unable to meet local needs for critical items (e.g., food, water, fuel, medical supplies), the picture changes. State and federal government agencies and/or nongovernmental organizations are then invited by the local or state jurisdiction to provide assistance in the days preceding and immediately after a major storm to help meet the affected citizens' needs (with the scale of external assistance depending upon the scale of the event itself, see Box 4.1).

“Relief supply chains” have protocols and procedures to follow as the storm progresses, responding to requests from local government officials who seek to meet the needs of their constituents. While political leaders and citizens both welcome—and indeed demand—these relief efforts, a large influx of emergency response supplies can sometimes have unintended negative consequences on local economies and supply chains.

Supply chains are based on the availability of resources for the manufacture and distribution of goods (e.g., people, equipment, systems), but these resources are finite. For instance, constraints in the distribution of commodities exist because there are only so many trucks, barges, ships, freight cars, and airplanes in a given part of the world. There is likewise finite capacity to produce food, potable water, medicine, and medical equipment. When hurricanes or other major disruptions occur, relief supply chains might temporarily replace, supplement, or “borrow” resources (e.g., supplies, transportation services) from commercial supply chains to deliver critical items or services to those in need.

Most government officials tend to ask for an over-abundance of aid in an effort to avoid any kind of shortfall in responding to the population's needs; with many different government officials asking for help, there are often overlapping requests that can overwhelm the system. When emergency agencies such as FEMA mobilize, they do everything in their power to

**Box 4.1****Disaster versus Catastrophe**

Some scholars have long argued that when planning emergency response efforts, it is critical to differentiate between a disaster and a catastrophe. A non-catastrophic disaster is one in which the local population, authorities, and humanitarian organizations can cope with the consequences despite significant casualties and destruction of infrastructure. In contrast, catastrophes can be defined as high-consequence events that generate widespread and crippling impacts, where the ability of the impacted society to respond is severely compromised (Quarantelli, 2006). This distinction can have important implications for emergency management policies. As discussed in Holguín-Veras et al. (2014b):

In a disaster, the local social networks involved in commercial logistics are typically able to respond, local resources may provide a first wave of aid, local supply chains respond fairly quickly, and local distribution of supplies may be organized relatively rapidly. In contrast, after a catastrophe local social networks are likely to be severely disrupted, available supplies will be minimal, private-sector supply chains may be out of operation for weeks, there will be a huge increase in demand for supplies, and a complex distribution effort will be required to satisfy the needs of both survivors and the responders.

In looking at the 2017 hurricane season, one could label the aftermath of Hurricane Maria in Puerto Rico as the closest to an example of a catastrophe. Yet even in this case, while local response capacity and commerce were severely compromised, they were not “destroyed,” and many businesses and supply chains proved surprisingly resilient.

In catastrophic situations, there may be a true need for an extended time line and scope of delivering critical relief supplies. But an overly-long or poorly targeted emergency response effort can make a disaster look like a catastrophe if it undermines the ability of local assets and systems to resume operations.

fulfill the requests that they receive from local agencies. However, because FEMA does not possess unlimited internal resources, materials, and infrastructure capacity, the agency often hires and contracts for local resources (e.g., materials, trucks, ships, barges, and operators) to help it fill the needs expressed by local and state governments.

*Example:* In Puerto Rico during Hurricane Maria, the primary port at San Juan became clogged as large relief shipments of food and bottled water overwhelmed the local trucking capacity for delivering goods across the island.

Such dynamics create an inevitable tension, because the resources that FEMA requires to accomplish its goals are often the same resources needed by local businesses to get their

## STRENGTHENING POST-HURRICANE SUPPLY CHAIN RESILIENCE

supply chains back to normal through regular delivery of goods and services to stores, homes, and hospitals. In many cases, demand by FEMA and other emergency management groups can outstrip the local market for resources such as fuel, trucks, drivers, barges, and warehouse space in the affected area. Compounding this tension, the contracted equipment and resources sometimes end up sitting idle, because too much was secured in an over-abundance of caution. The unfortunate result is that consumers and storm victims may experience a longer recovery period back to “normal” than necessary while waiting for resources to be freed up and reallocated to normal pre-disaster use.

*Example:* In the U.S. Virgin Islands, FEMA paid higher rates to a shipping company to handle relief supplies, and as a result, the company prioritized those shipments ahead of needed commercial resupply to retailers, thus delaying their reopening.

A major reason why the shift from emergency “push” to normal supply chain operations does not occur more quickly is insufficient collection and sharing of information before, during, and after the disaster. FEMA and other emergency managers lack needed contacts, systems, and communications processes to help them gauge conditions, capabilities, vulnerabilities, and criticality of pre-disaster supply chains and thus understand when the transition from emergency posture back to normal can take place. In many places the communications and information sharing among FEMA and other key public and private sector representatives are insufficient to support strategic decisions regarding when to pull back response efforts and allow resumption of normal, pre-disaster supply chain operations.

The concept of resilience is commonly defined as the ability of a system to bounce back in the face of a disturbance. More specifically, Bruneau et al. (2003) suggest that in trying to quantify the resilience of a system, of a community, etc., one can identify specific performance measures related to reduced failure probabilities, reduced consequences from failures (in terms of lives lost, damage, and negative economic and social consequences), and reduced time to recovery (restoration of a specific system or set of systems to their “normal” level of performance).

Such measures could be applied in many ways, at varying degrees of detail and complexity, to quantify the resilience of supply chains for critical commodities. On a simple level, however, one could argue that the most direct measure of success for post-hurricane supply chain resilience is how quickly and fully the local supply chains can bounce back to their normal pre-storm conditions. This goal is distinct from aiming to maximize the throughput of relief supply chains.

**Recommendation 1. Shift the focus from pushing relief supplies to ensuring that regular supply chains are restored as rapidly as possible through strategic interventions.**

Some key steps and strategies to advance this recommendation include to

- *Acknowledge political pressures for pushing relief supplies and define alternative measures for evaluating FEMA's success.* Political leaders often fail to recognize that strategically pulling back emergency efforts at the proper time is necessary for getting normal businesses and services back up and running. Often elected officials will continue to request resources from FEMA to ensure that their communities have access to critical goods and services, even when there is no clear indication that such supplies are needed.

This political pressure influences how FEMA is evaluated. The success of a response is often judged by the *amount* of relief supplies pushed into an area rather than the ultimate impacts of that push. Alternative measures by which FEMA could be evaluated might relate to the strength of an area's recovery, for instance, based on the speed of critical infrastructure restored; the number of local grocery stores, pharmacies, and gas stations re-opened; and/or the number of drivers and trucks returned to normal business activities.

- *Advance pre-disaster coordination and planning with key supply chain actors.* FEMA is in a unique position to lead cross-functional efforts between public and private sector entities (including small businesses, local governments, and others with limited resources) to coordinate pre-disaster planning discussions and exercises and to establish a core group of individuals from those groups to aid in determining the proper time to ramp down emergency push response and begin transitioning back to pre-disaster supply chain operations. Improved planning and communications will provide FEMA with a better view of the resilience, capacities, and limitations of stakeholders in critical supply chains and thus better understanding of when companies and critical public services can resume operations. Strategies to address these information and communication needs are discussed in the following sections of this chapter.
- *Prioritize recovery of infrastructure critical for resuming normal supply chain operations over delivery of materials.* Critical infrastructure (e.g., power, telecommunications, transportation, roads, bridges, water) enables the operations of all supply chains. In most cases examined in this study, adequate supplies of materials existed in the areas affected by disasters, but the ability to ship and deliver those supplies was impeded by lack of roads, trucks, drivers, fuel, or electricity. Repair and rebuilding of damaged infrastructure is not currently seen as FEMA's direct role, but the agency could be well positioned to take a more active leadership role in aiding such efforts.<sup>1</sup>

---

<sup>1</sup> Such efforts would need to be in partnership with key private sector stakeholders, sector-specific agencies (discussed later in Chapter 4), and organizations such as the Department of Homeland Security (DHS) Cybersecurity and Infrastructure Security Agency.

## STRENGTHENING POST-HURRICANE SUPPLY CHAIN RESILIENCE

For example, as part of a strategic shift toward greater focus on restoration of pre-disaster supply chains, FEMA could aid and advise the information gathering and analysis needed to identify priorities for restoration of critical infrastructure in an affected area (e.g., a manufacturing plant that is critical for a national supply chain may not normally be on the state or local emergency management radar for priority assistance).

## 4.2 BUILDING SYSTEM-SCALE UNDERSTANDING

Supply chain management plays an important role in preparing for, responding to, and recovering from disasters—encompassing activities as diverse as developing early warning systems, pre-positioning and distributing relief supplies, evacuating affected populations, and managing storm debris (Çelik, Ergun, and Keskinocak, 2015). Such roles must be fulfilled in the face of numerous challenges—such as high uncertainty, dynamic conditions, disrupted infrastructure, and scarce resources. Figure 4.1 illustrates the diverse and highly interdependent information-gathering, preparedness, and response actions and needs involved in building resilient supply chains before, during, and after a disaster strikes. The reference to “supply chain dynamics” used here refers to this dynamic system, which stretches across multiple sectors, temporally across the different stages of the “disaster cycle,” and spatially across local, state, national, and global-scale governance and supply chains.

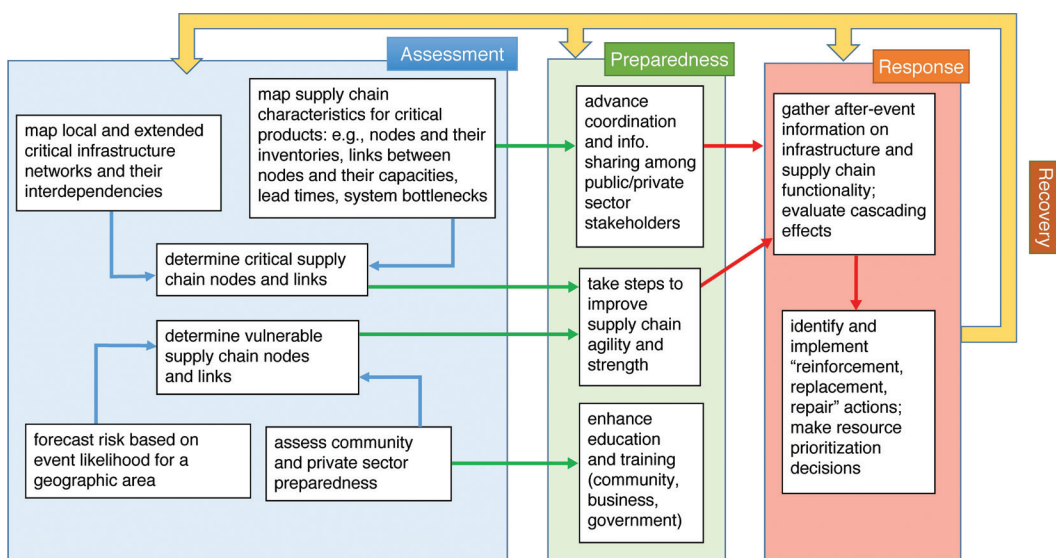

**FIGURE 4.1** Illustration of the different types of actions (and linkages and dependencies among them) to be addressed across the “disaster cycle.”

This section explores the types of data collection and assessment frameworks and practical decision support tools that are needed to build system-scale understanding of (and approach to managing) supply chain logistics in the face of hazardous events—and explores how this more comprehensive understanding can help shape the decisions and actions of emergency managers and other key officials facing complex, rapidly evolving disaster scenarios.

### **Understanding Supply, Demand, and Critical Infrastructure to Inform Preparedness and Response**

Building system-scale understanding of supply chains requires collecting and assessing information that elucidates how critical goods and services flow into, through, and out of a given area—and how major disruptions such as hurricanes can affect these flows. Particularly important is assessment of information related to supply and demand and to critical infrastructure, each discussed below.

During a disaster, assessing the availability of product *supply* and how it flows is challenging (i.e., how much through relief or commercial supply chains, to which locations), as it changes over time. For example, suppose one receives information that 80 percent of the grocery stores in the affected region are open at a given time after a disaster. While this partial information is helpful, it does not contain information about the general capacity at which each store is able to operate (such as what and how much inventory is on the shelves and whether stores are operating under limited hours). The answers might differ from location to location, causing varying amounts or types of unmet demand.

Assessing and forecasting product *demand* is likewise challenging, especially during disaster response. The demand and needs of the affected population change dynamically over time, depending on the disaster type and the phase in the disaster timeline, as well as local preparedness. Affected survivors in need of relief commodities might need them at different levels of urgency (Çelik et al., 2012). Hence, it is necessary to not only estimate the location and magnitude of demand and needs, but also differentiate between different demand classes (e.g., based on geography or sub-populations), along with the uncertainty of demand.

Immediately before and after disasters, there is often a surge in demand for certain items. In some cases, this is due to an actual need. In other cases, counter-intuitively, the demand can outstrip the true need. For instance, if local residents are concerned about supply shortages (e.g., food, water, gas), they may rush to stores and gas stations to hoard these supplies. Shortages resulting from this surge in demand may further increase the sense of scarcity and result in even more apparent demand. Without detailed information, it can be difficult to discern between observed demand and true needs of the population. And in addition to understanding the amount, type, and location of demand, it is important to understand how well regular supply chains can meet that demand. When there is unmet demand, this is not always due to a supply shortage, but may be caused by challenges in delivering the supplies to those in need.



## STRENGTHENING POST-HURRICANE SUPPLY CHAIN RESILIENCE

*Example:* In Puerto Rico after Hurricane Maria some grocery stores were open with items on the shelves, but they were not able to execute EBT card transactions due to power outages or disruptions in communication towers. Deliveries from distribution centers to grocery stores were also disrupted due to road conditions or shortages of truck drivers. In Florida after Hurricane Irma, some gas stations did not operate at capacity even though they had inventory of fuel, because people were not available to staff the stores. So, even though there was supply in these examples, human resource limitations or disruptions in the infrastructure led to a mismatch between demand and supply.

If one develops an understanding of how well critical supply chain components can meet demand during “normal” times, this often provides insights on where the biggest gaps and vulnerabilities that are likely to arise during emergencies: where will relief items most likely need to be delivered, and what preparation steps could be taken to reduce post-disaster response needs?

*Example:* The United States regularly experiences shortages of some lifesaving drugs and other supplies essential to patient care. Saline is one example, as it is required for the majority of hospitalized patients, with national demand of more than 40 million bags per month. One of the main producers of saline, supplying about half of U.S. hospitals with small saline bags, is Baxter International, located in Puerto Rico. There was already a shortage of saline solution prior to Hurricane Maria, and the impact of the hurricane on the Baxter plant caused the problem to reach critical levels. The lack of redundancy in overall manufacturing capacity makes this a highly vulnerable supply chain (Mazer-Amirshahi and Fox, 2018).<sup>2</sup>

Supply chains rely on *critical infrastructure* such as power, communication, transportation facilities (e.g., roads, airports, ports)—all of which can be damaged and disrupted during a disaster. The magnitude of damage, and how quickly the system can recover from damage, depends on the resilience of the infrastructure; and the status of the infrastructure, in turn, can profoundly affect supply and demand (and ability of supply chains to meet the demand) for many critical products and services. See, for example, the discussion in Chapter 3 about the infrastructure vulnerability in Puerto Rico, and how the infrastructure failures that resulted from Maria became a central factor undermining almost all critical supply chains across the island.

In the context of emergency preparedness and response, the definition of critical infrastructure can be expanded beyond the traditional sectors noted above. The DHS extended

---

<sup>2</sup> See <https://www.fda.gov/NewsEvents/Newsroom/PressAnnouncements/ucm592617.htm>, and <https://www.cbsnews.com/news/why-so-many-medicines-are-in-short-supply-after-hurricane-maria/>.

definition of critical infrastructure includes 16 sectors,<sup>3</sup> with associated sector-specific agencies (discussed in Section 4.3). Among these are energy (Department of Energy), health care and public health (Department of Health and Human Services), water and wastewater (Environmental Protection Agency), food and agriculture (U.S. Department of Agriculture; Department of Health and Human Services), and critical manufacturing emergency services (DHS).

Mechanisms that allow system-scale understanding and visibility of all of these complex, interacting elements (related to supply, demand, critical infrastructure) can provide a critical foundation for advancing the other goals recommended in this report.

- As discussed under Recommendation 1, disaster response efforts often focus on delivering relief and services based on rough estimates about unmet demand, rather than on an understanding of the root causes for unmet demand and identifying what interventions could help normal supply chains rebound more quickly—and in some circumstances, this approach can actually delay the recovery of regular supply chains. Emergency management officials need system-level information and decision support tools to better understand when to phase out of relief supply chains and how to most strategically intervene to help commercial supply chains resume in a timely manner.
- As discussed under Recommendation 3 (below), effective preparedness actions can greatly reduce the need for external aid, demands on relief supply chains, and the timeline for recovery. Preparedness can encompass many types of activities, however, with priorities varying from one place to another. In some places, mitigating potential infrastructure failures may be paramount, whereas in other places, advancing debris management planning is a high priority (see Box 4.2). With a broader systems perspective, investments and attention among different preparedness actions can be better prioritized.
- Finally, as discussed under Recommendation 4 (below), emergency management training efforts could be greatly enhanced with tools that build understanding about the system-scale dynamics of supply chains and the ways in which emergency preparedness and response decisions will affect those dynamics.

### **Understanding Dependencies and Cascading Effects to Inform Resource Prioritization**

Decisions about the allocation of scarce resources are critical during disaster response, and these decisions can have complex cascading effects on other resources and on the ability to meet demand for certain commodities within an affected community. For example, allocating the limited truck capacity to delivering critical food and medical items may save or improve

---

<sup>3</sup> See <https://www.dhs.gov/cisa/critical-infrastructure-sectors>.



## STRENGTHENING POST-HURRICANE SUPPLY CHAIN RESILIENCE

**Box 4.2****Use of Decision Support Tools for Debris Management**

The challenge of managing debris generated after a disaster can help illustrate some concepts discussed in this section—as the decisions involved are complex, the impacts are large, and the needed activities cut across all stages of the disaster timeline.

Clearing post-storm debris from roads and ports can impact search and rescue; evacuation; distribution of food, water, and medicines; access to critical services; and restoration of power and telecommunication services. As discussed in a report by the Environmental Protection Agency: “safe, proper, and timely management of debris is an essential but often overlooked component of an emergency response or disaster incident. . . . It involves advance thought, planning, and coordination among individuals at various levels of government and the private sector with experience and expertise in waste management.”<sup>a</sup> A report by the DHS Office of Inspector General found that FEMA spent more than \$8 billion during 2000–2010 for post-disaster debris removal, and that “better planning, contracting, and oversight of debris operations . . . could enable these operations to be conducted in a more cost-effective manner” (OIG, 2011).

Debris management poses particularly acute problems in small island settings. As discussed in Palin et al. (2018), Hurricanes Irma and Maria produced more than 1 million cubic yards of debris in the U.S. Virgin Islands, where they faced the challenges of no viable landfills, citizen opposition to incineration plans, regulatory restrictions on exporting, little pre-event debris management planning, and no established pre-incident agreements for off-island debris disposal. Significant federal intervention (by the Army Corps of Engineers, FEMA, and the Environmental Protection Agency) was needed to address this problem.

As illustrated in Figure 4.2, debris management decisions are made during pre-disaster preparations (planning and construction of sites or facilities for debris processing or disposal), post-disaster response (debris clearance and collection), and longer-term recovery (debris disposal). Debris clearance involves allocating limited resources and determining the best sequence for clearing debris-blocked roads (Çelik, Ergun, and Keskinocak, 2015). Debris collection involves critical decisions about how to allocate collection zones to different contractors in a way that optimizes time, overall cost, and fairness. Debris disposal involves decisions about locations and technologies for debris-processing facilities, considering collection and disposal time, environmental impact, costs, and potential revenue from recycled debris.

Information about the type, amount, and location of debris is often very limited in the immediate aftermath of a disaster, making it difficult to estimate the resources required and the clearance time. Hence, debris management activities could significantly benefit from better data collection, quantitative models, and decision-support tools. Examples of such tools include the following:

- The incidence waste management tool provides information and guidance to ensure the safe and efficient removal, transport, and management of waste materials.<sup>b</sup>
- Light detection and ranging (LiDAR) technology can be used to estimate debris resulting from hurricanes, and was used following Hurricane Katrina (Hansen et al., 2007) and Hurricane Sandy (Xian, Lin, and Hatzikyriakou, 2015).

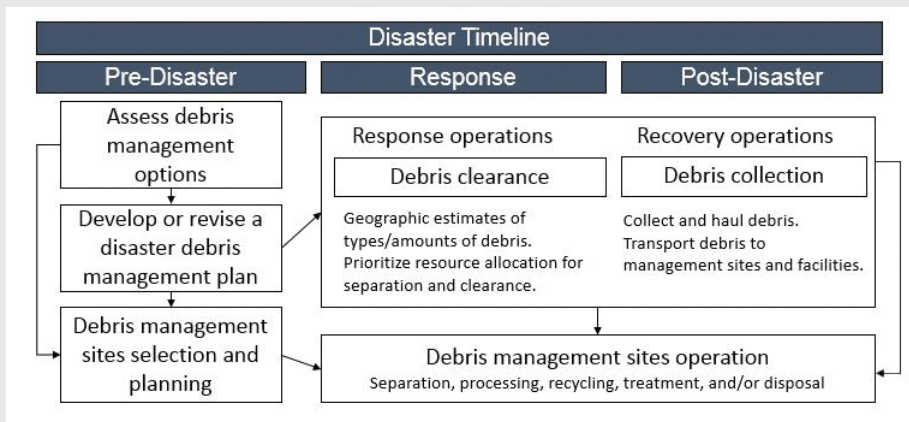

**FIGURE 4.2** Post-disaster debris management operations components.

SOURCE: <https://debrismanagement.gatech.edu/>.

- Hazus uses geographic information systems to illustrate high-risk locations and estimate potential losses from earthquakes, floods, and hurricanes.<sup>c</sup> The information can support risk assessments prior to and rapid needs assessments during hurricane response.
- A prototype decision-support tool has been developed by researchers at the Georgia Institute of Technology to support debris disposal decisions, focusing on pre-disaster planning for processing and disposal sites locations, capacities, and capabilities (Lorca et al., 2017).
- Crowdsourcing and social media<sup>d</sup> (Havas et al., 2017) and unmanned aerial vehicle technologies<sup>e</sup> are being increasingly used to gather information and situational awareness for debris management efforts.

With these sorts of advancements, post-disaster debris operations have great potential to improve. In addition, the development of quantitative models embedded into simple decision-support tools can improve the timeliness, cost, and effectiveness of debris management decisions at all stages of the disaster management timeline.

<sup>a</sup> See <https://www.epa.gov/large-scale-residential-demolition/disaster-debris-planning>.

<sup>b</sup> See <http://www2.ergweb.com/bdrtool/login.asp>.

<sup>c</sup> See <https://www.fema.gov/hazus>.

<sup>d</sup> See <https://www.fema.gov/blog/2013-08-02/crowdsourcing-disasters-and-social-engagement-multiplied>.

<sup>e</sup> See <https://www.cnn.com/2013/05/23/tech/drones-the-future-of-disaster-response/index.html>.

## STRENGTHENING POST-HURRICANE SUPPLY CHAIN RESILIENCE

lives; yet allocating some of that capacity for carrying repair supplies to fix critical infrastructure (e.g., roads, electricity) might also save lives, especially if this means establishing connectivity to critical facilities and services such as hospitals and dialysis centers. The impacts of allocation decisions can reach well beyond local communities as well. For example, if there are delays in the shipments of jet fuel, air transportation throughout the country could be affected.

Resource allocation and prioritization decisions can be especially challenging if these decisions are made by multiple agencies in a decentralized manner. With tools that provide visibility into the evolving demand, supply, and infrastructure conditions, decision makers can have a better understating of how particular response decisions may lead to cascading impacts across economic systems and geographic scales.

Critical to this process is establishing how (and by whom) prioritization decisions are made during an emergency. Among the many questions that must be asked are: Are there protocols in place for prioritization? If yes, were these protocols prepared with input from stakeholders? Are these protocols communicated broadly to ensure that everyone is aligned in understanding their respective roles and responsibilities? What kind of flexibility is built into these protocols, so that priorities can change dynamically as more information becomes available? Who coordinates to make sure that the priorities are adjusted as needed and understands the critical interdependencies among different networks, demand, and supply?

Understanding how interdependencies among critical systems can lead to cascading failures aids in emergency preparedness and supports risk management decision making when responding to events. For example, as noted above, many critical supply chains are dependent on the functioning of critical infrastructure such as energy supply (electricity, fuels), and in turn the energy sector is often dependent on the functioning of communications, water, and transportation systems. A widespread power outage—especially if it lasts for an extended period—is likely to impact the communications network, the water network, and critical supply chains for fuel, food, and other critical supplies. If road infrastructure is damaged, this can delay repairs in other infrastructure as well as response and recovery efforts. Risk analyses and assessment of critical assets and networks can reveal unknown or unforeseen dependencies and interdependencies.

The 2017 hurricanes offered numerous examples of challenges in the prioritization of scarce resources and the cascading impacts of infrastructure failures or resource allocation decisions.

*Example 1:* In the response to Hurricane Maria in Puerto Rico, containers generically marked as “disaster relief” were prioritized over other containers that held critical materials such as repair parts for generator maintenance and resin to make caps for bottled water production. Dialysis centers, which require significant amounts of water to run, were not always prioritized at the level they needed. In the U.S. Virgin Islands, delivery of badly needed repair and rebuilding supplies was delayed by less critical “relief supply” shipments.

*Example 2:* During Hurricane Maria, the collapse of power and communication infrastructure across Puerto Rico created a host of cascading effects on supply chain dynamics. Many truck drivers could not be reached due to non-functioning communications networks, and this became one of the factors causing a shortage of truck capacity and thus delaying delivery of critical goods. Without power and communication, retailers could not place orders with distributors, distributors could not place orders with suppliers, and orders could not be delivered due in part to the inability to mobilize trucks and drivers.

*Example 3:* During Hurricane Harvey, power and communication outages, as well as fuel and chemical shortages, affected water pumping and treatment facilities throughout the South Texas region. Flooding and damage to critical infrastructure also greatly impeded the distribution of food, water, and medical supplies.

*Example 4:* During Hurricane Irma, a fueling center located near Ft. Pierce, Florida, a key location, particularly for major truck transports and deliveries, ran out of fuel and convenience store products before the storm due to high evacuation demand, and it lost electricity a day later. Restoration of fuel and food supplies was hindered by the lack of power. The local electric utility and the facility store manager had never been contacted by emergency management or utility officials regarding priority restoration of power nor had the owner ever communicated with local authorities.

Another factor that can have system-wide cascading impacts are the rules and regulations stemming from national legislation or standard operating practices. Understanding such impacts can aid wise, informed decisions about whether, where, and when to seek waivers or adjustments to such constraints before and during emergency events. Such rules and regulations may also lead to misalignment of incentives in the system and have unintended consequences. For instance, price gouging restrictions meant to protect customers from improper price surges can lead some retailers (especially small stores or gas stations) to temporarily shut down operations due to concerns that selling prices are not sufficient to cover higher costs of supply replenishment. (See Appendix D for a complete listing of regulations and waiver opportunities.)

*Example:* When damage from Hurricanes Harvey and Irma threatened fuel supplies nationwide, temporary waivers to the Jones Act were issued, allowing foreign vessels to transport petroleum products between the Gulf Coast and the eastern seaboard.<sup>4</sup>

---

<sup>4</sup> The Jones Act prohibits any foreign-built, foreign-owned, or foreign-flag vessel (foreign vessels) from transporting goods between U.S. ports. During the 2017 hurricane season, Jones Act waivers were issued three times. The first two dealt with fuel supplies impacted by Hurricane Harvey and Irma. The last waiver was specific to Puerto Rico (due to Hurricane Maria) and addressed the movement of all products. Note that the U.S. Virgin Islands is exempt from the Jones Act. See Appendix D for further information on the Jones Act.

## STRENGTHENING POST-HURRICANE SUPPLY CHAIN RESILIENCE

During Hurricane Irma, gasoline shortages were thought to be due in part to the lack of drivers certified to enter the local fuel racks. This bottleneck could be largely alleviated if private sector and local officials collaborate in establishing a fast credentialing process for out-of-state (HAZMAT-certified) truck drivers coming to use the local racks, or it could be coordinated through private sector mutual aid organizations.

### Practical Implementation Considerations and Examples

Figure 4.1 highlights many of the information-gathering activities needed to build the type of system-scale understanding discussed here (e.g., mapping critical infrastructure networks and interdependencies, identifying critical and vulnerable supply chain nodes and links, characterizing the preparedness status of key stakeholders). There is a great deal of work involved in gathering, verifying, maintaining, and analyzing such a complex collection of information and in using this information to develop appropriate models and decision-support tools. This work does of course have costs, but these costs are likely to be far outweighed by the benefits of equipping emergency managers with better understanding of supply chain vulnerabilities, with visibility into the causes of demand and supply gaps, and with a stronger foundation to make effective decisions about how, when, and where to deploy critical resources during emergency preparedness and response operations.

We do not attempt to offer here a detailed blueprint regarding questions of practical implementation, such as what specific data and indicators should be collected, at what level of spatial and temporal granularity, or how the specific modeling and decision-support tools should be structured. The answers to these questions will vary a great deal depending upon the location of study, the hazards of key concern, the supply chains of critical interest, and other factors, and it can in fact take months or years of work to design such systems.

As more general illustrative guidance, however, we point to several examples of these sorts of tools that are already being developed and applied in a variety of disaster and hazard management contexts (see list below, as well as Box 4.3):<sup>5</sup>

- Kotsireas, Nagurney, and Pardalos (2018) survey a variety of modeling approaches and applications to natural and human-caused disasters.
- Uluhan and Ergun (2018) use a network science-inspired measure to quantify the criticality of components within a disrupted service network and offer a methodology to prioritize restoration efforts based on this measure—focusing in particular on the challenge of setting priorities for clearing road debris in the aftermath of a natural disaster.

<sup>5</sup> The Massachusetts Institute of Technology work described in Chapter 1 is an attempt to do the type of systems modeling described here; however, that work is still in an active development stage and thus not included in this list.

**Box 4.3****Example of an Application of System-Scale Information and Decision-Support Tools**

The World Food Programme (WFP) supported the development of Optimus, a model that optimizes several critical elements of WFP's complex food assistance relief and long-term recovery planning—including, for instance, the food baskets to be delivered, the sourcing plans, the routing plans, and the transfer modality (described in Peters et al. (submitted)). This effort began with initial supply chain assessment studies conducted by WFP and academic partners, to determine the scope of the decision-support tool, identify the data needs, and develop prototypes. This was followed by efforts to build the data collection, integration, and management systems needed to enable operational use of the modeling tools. WFP also began hiring people with modeling, systems, and data analytics expertise to help support the supply chain optimization initiative. Web-based tools were then eventually deployed and used in operations.

The first significant benefits achieved from using the tool were reported in the WFP Supply Chain Division's 2016 annual report (WFP, 2017)—roughly six years after the initial development studies began. WFP used these tools to optimize its food basket for Iraq and saved more than US\$13 million (17 percent compared to the previous year). This example illustrates that developing and implementing complex decision-support systems does require considerable time and effort, but, ultimately, these systems can significantly reduce supply chain operational costs.

- Nurre et al. (2012) examine models and tools for restoring infrastructure system services after disruption from an extreme event, including the use of decision models to prioritize restoration actions and schedule limited resources in order to maximize supply flows.
- Ergun et al. (2011) and Duran, Gutierrez, and Keskinocak (2011) explore how operations research methodologies and optimization models can be used to assist decision makers addressing common disaster response supply chain challenges, such as advance purchasing, pre-positioning, and inventory allocation. They also explore more intuitive scenario-based approaches for addressing objectives that are difficult to model quantitatively.
- Doroudi et al. (2018) harness behavioral operations research to advance methodologies for testing and improving supply chains, addressing human components of the system. Focused on the problem of shortages of key pharmaceutical drugs in the United States, they developed an integrated simulation framework that can predict how disruptions may cascade through pharmaceutical supply chains and that allows one to “integrate sophisticated supply chain models with realistic, yet computationally tractable, models of human decision making.”
- Mendonça and Wallace (2004, 2007) examine the importance of flexibility and capacity to improvise in responding to disasters; and develop a set of requirements for computer-based systems to provide cognitive-level support for improvisation in response to extreme events.

## STRENGTHENING POST-HURRICANE SUPPLY CHAIN RESILIENCE

- Çelik et al. (2012) present several examples of decision support tools being developed to aid in estimating demand for relief supplies—for example, for informing decisions about prepositioning of supplies, designing optimal procurement strategies to minimize costs and maximize benefits to local communities, and assessing local health system capacity to meet demand within an affected area.
- Duran, Gutierrez, and Keskinocak (2011) describe a model developed for CARE International to evaluate strategies for positioning relief items in order to reduce relief-aid response time. The model has been used to help CARE managers determine a desired configuration for pre-positioning networks located in several countries around the world.

**Recommendation 2. Build system-level understanding of supply chain dynamics as a foundation for effective decision support.**

Some key steps and strategies to advance this recommendation include the following:

- For the given jurisdiction of concern (i.e., local, state, regional), support pre-disaster assessment of the criticality, vulnerability, and dependencies of key supply chain nodes, links, and supporting infrastructure; and develop protocols and systems for gathering and regularly updating information about demand, supply, infrastructure condition, and supply chain functionality. Many private sector supply chains already utilize sophisticated tools for sensing supply and demand changes, system bottlenecks and vulnerabilities, and other critical information. Public sector officials need comparable capabilities and tools that can interface with, and build upon, these private sector capabilities.
- Emergency management offices at the local, state, and regional levels (working with critical partners, for instance, in the private sector and in academic research centers) are likely best suited to lead much of this information collection and analysis work. FEMA can play a critical leadership role, however, in building capacity and providing support for such efforts—not only through financial incentives (i.e., grant programs) but also through active training activities that bring together local knowledge with experience and perspectives drawn from government and business leaders nationwide (training issues are discussed further below).

### 4.3 ADVANCING PREPAREDNESS, COORDINATION, AND INFORMATION SHARING

#### Preparedness Measures to Build Supply Chain Resilience

By far the greatest opportunities for ensuring more effective conveyance and distribution of critical relief supplies in the wake of a disaster come from efforts undertaken before disasters strike. Individuals, governments, and businesses often have a short memory of past



disasters and adopt unrealistically positive attitudes of “it won’t happen to me,” which is why it is so important to actively promote continual disaster preparedness efforts and to preserve the critical institutional memory and expertise that allows one to build upon past successes and failures. Discussed below are some of the critical planning steps that can be taken by emergency managers, businesses, owners and operators of key supply systems, and other local stakeholders involved in ensuring that supply chains remain resilient in the face of disruptions.

### *Emergency Preparedness and Continuity of Operations Plans and Resources*

Over the past decade, business continuity planning has expanded significantly, particularly in advance of hurricane season, because of growing pressure for companies to recover quickly (often within hours) after a storm hits and to maintain significant capabilities during disaster conditions.<sup>6</sup> Such plans need to be regularly reviewed and updated to prepare for potential catastrophic events that affect widespread geographic areas and affect critical infrastructure. Plans should consider how to manage resources by understanding and taking inventory of critical business functions, sites, materials, and equipment needed for response and recovery operations. This may include consideration of factors such as transportation and communication equipment, off-site back-up locations and capabilities, supplies of essential materials (e.g., water, ice, food, fuel, batteries, generators), and robust contracts with suppliers who can respond quickly during an emergency and enable continuity of operations (see Box 4.4).

*Example:* Caribbean Restaurants, operator of more than 170 Burger King locations across Puerto Rico, was well equipped to handle problems after Hurricane Maria—because it had inventories, communications systems, and workers ready to respond. It was able to rely on an experienced network of drivers and an internal fleet of 25 trucks to deliver product to its stores. It also benefited from a company-owned 10-day supply of diesel, supplemented with fuel shipments from longtime supplier Empire Gas—which in turn had its own distribution channels, containers, and fleet of trucks to distribute gas across 40 different stations throughout the island.<sup>7</sup>

### *Training and Worst-case Scenario Drills for Preparedness, Response, and Recovery Operations*

Training programs provide a necessary step in preparing for disaster incidents. In addition to training, personnel should exercise plans to test and evaluate roles and responsibilities, procedures, communications, and equipment. Lessons learned and best practices that were observed during exercises can then be used to update existing plans to make them more robust. Federal, state, and local governments and the private sector sometimes conduct exercises and workshops to prepare for disaster incidents.

---

<sup>6</sup> See [https://www.travelerscanada.ca/iw-documents/58668RMG-CA\\_BusinessContinuity.pdf](https://www.travelerscanada.ca/iw-documents/58668RMG-CA_BusinessContinuity.pdf).

<sup>7</sup> See <http://investigations.debtwire.com/how-burger-king-fed-storm-ravaged-puerto-rico-and-made-a-killing/>.



## STRENGTHENING POST-HURRICANE SUPPLY CHAIN RESILIENCE

**Box 4.4****Fuel Supply Contingencies: Contracts and Agreements**

A key priority of preparedness in the aftermath of major storms is ensuring the availability of fuel for response, restoration, and recovery activities. Depending on market conditions, fuel inventories may be low and prices high as demand for tight supplies increases. Both private and public entities often experience fuel supply shortages during disaster events, and according to the American Petroleum Institute, “stakeholders are often unaware of what is needed to purchase fuel or what laws and regulations apply to purchases in their states” (API, 2016).

Businesses and governmental organizations (particularly state and local governments) may seek to reduce costs during normal operations by purchasing fuel on the “spot market”; but when emergencies strike, fuel supplies purchased through such arrangements can become limited or nonexistent. As fuel demand by public and private entities increases (e.g., following a major evacuation order), finding fuel to purchase on the market becomes difficult, and suppliers and users of fuel often have to travel long distances or out of state to procure supplies. During a shortage, customers with contracts or agreements via a primary fuel supplier are typically served first. During tight fuel markets, customers with contractual agreements may be given priority to purchase an allotted level of fuel based on previous historical purchases at their fuel supply facility or terminal.

*According to the National Association of State Energy Officials, “prior to any disruption, states may wish to consider training critical user organizations about the differences in spot and contractual purchases and the issues and techniques that can be used to balance price versus security of supply” (NASEO, 2018). When feasible, establishing firm contractual agreements is a good option for ensuring that companies and organizations are prepared for the next major event.*

*Example:* In June 2017, two months before Hurricane Harvey, Texas State Emergency Management conducted an exercise to test the state’s hurricane preparedness program. The scenario was a major Category 4 hurricane to make landfall in the Houston-Galveston-Sabine Lake region. More than 1,100 participants took part over the nine-day event.<sup>8</sup> In May 2017, the Department of Energy along with state organizations and private companies conducted the Clear Path V exercise in Houston that simulated a hurricane event (ISER, 2018).

**Communication Protocols and “Work-Around” Systems**

Effective communications among governments, private, and public entities are necessary in preparing, responding, and recovering from an emergency situation. Communication mechanisms and equipment should be deployed with appropriate back-up plans to agencies and organizations involved. Comprehensive communication systems, including the use of translators when

<sup>8</sup> See <http://www.dps.texas.gov/dem/temoArchives/2017/Vol64No8/articles/article4.htm>.

necessary, should be in place to supplement any communications that may be lost in the event of a power outage. Communications equipment should be thoroughly tested, and responders should become familiar with the equipment, systems, and procedures during training and exercises.

*Example:* After Hurricane Maria, more than 95 percent of cell signal towers in Puerto Rico were out of service (FCC, 2018), and emergency management officials reported how their staff operated “blindly” for a number of days and thus were not able to adequately respond due to lack of communications.

### *Plans to Protect Health and Safety of Organizational Personnel*

During a disaster, government and industry may experience a loss or shortage of human resources to perform critical jobs and provide adequate contingencies. Business continuity plans could include steps such as shutting down headquarters, evacuating workers, establishing temporary work sites, and arranging to bring in qualified replacement and backup personnel. Businesses should maintain lists of full contact information for all employees and ensure that lists are updated frequently and maintained at multiple locations. Preparedness plans should address relocation or return of evacuated employees to the region. Housing resources need to be identified for employees and their families. Safety and security requirements, including protocols for re-entry credentials, must be assessed and addressed prior to returning evacuated employees or deploying replacement employees.

*Example:* In Puerto Rico after Hurricane Maria, a significant number of truckers stayed home even after the ports had reopened and many roads had been cleared, because they could not risk being stranded without fuel (Palin, 2018). Also in Puerto Rico, Crowley Maritime housed and fed employees and their families at the Port of San Juan to ensure the availability of workers to continue operations. In Houston, it was reported that one large electric utility (CenterPoint) set up childcare services for its employees who responded to Hurricane Maria.

### *Partnerships That Enhance Coordination, Communication, and Information Sharing Among Government Agencies, the Private Sector, and Nongovernmental Organizations*

Effective communications among all levels of government and industry is important in developing coordinated messages to expedite response and restoration efforts and to inform the public of response and recovery progress during and after an incident. Information sharing and coordination strategies and platforms are discussed in greater detail below.

*Example:* In Puerto Rico, health care coalitions played an important role in advancing collaboration and coordination when storm damage led to the partial or complete closure of several hospitals. More so than most other sectors, hospital coalitions in

## STRENGTHENING POST-HURRICANE SUPPLY CHAIN RESILIENCE

Puerto Rico had a history of cooperative training and exercises, including exercises that involved scenarios of a Category 5 hurricane.<sup>9</sup> In Texas, there were also several examples of effective coordination across agencies. In Harris County, a wide array of organizations maintained communication and collaboration through the Emergency Operations Center. At the Port of Houston, the port coordination team consisted of more than 25 representatives from the weather service, Army Corps, oil refineries and other industries, barge operations, railways, Port of Houston, Port of Galveston, local law enforcement, and others. Conference calls during disaster response worked very efficiently because representatives already knew each other, had been working together for a long time, and had established a level of trust. Everyone had some level of understanding of the repercussions of the prioritization decisions.

### Federal Mechanisms to Advance Operational Coordination and Information Sharing

Operational coordination is a core capability of the DHS National Planning Frameworks (prevention, protection, mitigation, response, and recovery). Under the National Response Framework, government agencies, departments, and responders at the local, state, and federal levels interact with industry to respond to all types of disasters and emergencies. In 2016, DHS also issued its Critical Infrastructure Threat Information Sharing Framework to help key stakeholders understand threats information and protect critical infrastructure systems. Stakeholders include critical infrastructure owners and operators;<sup>10</sup> government entities at the federal, state, local, tribal, and territorial levels; and other public and private partners with responsibility for the security and/or resilience of critical infrastructure systems.

This framework facilitates the sharing of threat information through designated information-sharing hubs and by defining standard operating procedures for communicating information to key stakeholders. These information-sharing conduits and hubs may either directly or indirectly interact with critical infrastructure owners/operators and the private sector, depending upon their function. For example, information-sharing and analysis centers, managed by consortiums tasked with providing sector-specific analysis on critical infrastructure status and threats, can interact directly with infrastructure owner/operators. Each center not only acts as a clearinghouse for information shared (by government or private entities) with the greater industry community, but also serves as a resource to validate and analyze the information it receives in order to assess the severity of perceived threats and to recommend appropriate response actions. There are information-sharing and analysis centers for electricity, oil and gas, and water, as well as others.<sup>11</sup>

<sup>9</sup> See <https://www.phe.gov/Preparedness/planning/hpp/Pages/find-hc-coalition.aspx>.

<sup>10</sup> Much of the critical infrastructure in the United States is owned or operated by private companies. See, for example, DHS (2016).

<sup>11</sup> Electricity Information Sharing and Analysis Center: <https://www.nerc.com/pa/ci/esisac/Pages/default.aspx>; Oil and Natural Gas Information Sharing and Analysis Center: <https://ongisac.org/>; Water Information Sharing and Analysis Center: <https://www.waterisac.org/>.

In addition to its information-sharing framework, DHS developed a framework for successful public-private partnerships in the form of self-organized, self-governing sector-coordinating councils.<sup>12</sup> These councils enable critical infrastructure owners and operators, their trade associations, and other industry representatives to interact on a wide range of sector-specific strategies, policies, and activities. The sector-coordinating councils coordinate and collaborate with sector-specific agencies, the Critical Infrastructure Cross-Sector Council,<sup>13</sup> and related government coordinating councils to address the entire range of critical infrastructure security and resilience policies and efforts for that sector. Examples of cross-sector discussions include the electricity, oil and gas, financial services, and communications sector coordinating councils' collaborative work on dependencies and interdependencies to enhance response planning (NPC, 2014).

*Example:* A good illustration of how these structures function can be found in the chemical industry sector. U.S. chemical facilities produce a huge range of chemical products for a global supply chain. The sector has a strong history of public-private partnerships to develop industry practices focused on safety and security.<sup>14</sup> The chemical sector has a sector-specific agency that leads public-private partnerships, and a sector-coordinating council with representatives from 15 trade associations<sup>15</sup> that “provides a forum for private companies to coordinate on sector strategy, policy, information sharing, regulations, and risk management activities.” DHS’s sector-specific chemical government coordinating council works with the sector-coordinating councils to plan, implement, and execute sector-wide resilience and security programs. The government coordinating council also enables interagency and cross-jurisdictional coordination and communication on strategies, activities, and policies among government agencies.

The State, Local, Tribal, and Territorial Government Coordinating Council and the Regional Consortium Coordinating Council are examples of two councils focused on short- and long-term priorities in critical infrastructure resilience. The State, Local, Tribal, and Territorial Government Coordinating Council serves as a forum for different levels of government to coordinate across jurisdictions in national critical infrastructure security and resilience efforts, and the Regional Consortium Coordinating Council is a cross-sector council that provides a framework to support regional public-private partnerships including information sharing and networking. (See Appendix C for a list of consortiums participating in the Regional Consortium Coordinating Council.) A few examples of such councils are discussed below.

---

<sup>12</sup> See <https://www.dhs.gov/cisa/sector-coordinating-councils>.

<sup>13</sup> See <https://www.dhs.gov/cross-sector-council-charter-membership>.

<sup>14</sup> See <https://www.dhs.gov/cisa/chemical-sector>.

<sup>15</sup> See <https://www.dhs.gov/cisa/chemical-sector-council-partners>.

## STRENGTHENING POST-HURRICANE SUPPLY CHAIN RESILIENCE

*Example:* Two member groups of the Regional Consortium Coordinating Council that provided services and support during the 2017 hurricane season were the All-Hazards Consortium and the American Logistics Aid Network. The activities of the All-Hazards Consortium included coordinating the movement of personnel, equipment, and materials to provide power restoration. The consortium provides the technology and convening mechanism to enable this form of business-to-business mutual aid. The American Logistics Aid Network provided a cross-sector convening call to enable information sharing between government and businesses specifically around logistics and supply chain activities. This allowed for real-time conversation regarding issues common to all supply chains, as well as information exchange between FEMA Logistics Management Divisions' senior leadership and commercial supply chain professionals and industry association leaders.

Several key initiatives for information sharing among critical sectors are led by the National Infrastructure Coordinating Center, which serves as the private sector's connection to the security and resilience programs led and coordinated by DHS's Cybersecurity and Infrastructure Security Agency.<sup>16</sup> The National Infrastructure Coordinating Center supports the critical infrastructure community through its Homeland Security Information Network (HSIN, 2019).<sup>17</sup> The network is the primary system through which sensitive but unclassified information may be shared among private sector owners and operators (including for critical infrastructure), DHS, and other federal, state, and local government actors, particularly during catastrophic events. The Homeland Security Information Network can be used during hurricane response for activities such as receiving and sending updates on damage assessment and providing a valuable platform for information sharing.

For additional information on tools and resources for information sharing, see Appendix C.

### **Coordination and Information-Sharing Mechanisms: Experiences from the 2017 Hurricanes**

Emergency management efforts involve multiple agents (e.g., governmental agencies, nongovernmental organizations, industry, military), which can have conflicting objectives and may even at times compete for scarce resources. Hence, multi-organizational collaboration and coordination, within and across sectors, is crucial in the management of relief and commercial supply chains and the allocation of scarce resources. It takes time to establish the relationships and trust needed as a foundation of effective supply chain logistics, which is why it is so critical for representatives from key organizations (e.g., government, private sector, nongovernmental organizations) to engage early on—well before a disaster hits.

---

<sup>16</sup> Formerly the DHS Office of Infrastructure Protection.

<sup>17</sup> See also <https://www.dhs.gov/homeland-security-information-network-hsin>.

During the committee's meetings, numerous individuals and organizations were asked what factors they considered most necessary for successful disaster response, and many of the responses centered around the need for clearly defined processes and mechanisms for coordination and information sharing—especially platforms to engage across levels of government, with the private sector, and with the public—before, during, and after a disaster. The lack of effective information sharing and coordinated response were cited as factors that led to duplication of efforts, gaps in service delivery, confusion over ownership of issues, and, in severe cases, competition for scarce resources.

Several formal and informal mechanisms for coordination and information sharing, within and across sectors, were utilized during the 2017 hurricane season, with varying levels of efficacy. Below is an overview of some of the key platforms used, focusing in particular on activities to foster coordination and information sharing between government emergency management agencies and private sector businesses.

The National Business Emergency Operations Center (NBEOC), which is activated by FEMA following disasters or emergencies, engages stakeholders from the private sector and federal and state agencies to enhance communication and collaboration, to help FEMA offices with situational awareness, and to facilitate exchange of information for response and recovery. In the 2017 hurricane season, the center, as well as state emergency management organizations, hosted voice and web conferences, which allowed for a rapid distribution of high-level information to a broad audience. These NBEOC calls had upwards of 1,000 participants during the height of the storm activations. The calls utilized a structured agenda for reporting, along with a question-and-answer component, and utilized an interactive web-based dashboard where reports, briefings, maps, links, and other static information were posted. These calls focused on a push of information, although the question-and-answer period and web-based portion did allow for businesses to raise questions and issues. There is evidence that in some cases the web-based dashboard allowed for business-to-business mutual aid and resource sharing. While the calls were very useful, some challenges were identified with this format, such as the following:

- In areas where communications infrastructures (i.e., power, telephone, cellular towers) were disrupted or destroyed, this impeded critical efforts to distribute information, coordinate activities, and identify arising problems. The lack of physical communications capabilities prevented access to resources where information sharing and coordination activities were occurring.
- Some issues identified in the NBEOC calls were then worked on offline by a few key stakeholders, but those solutions were not shared broadly until the next call on the following day (which can be a long delay in the context of a fast-moving storm event).
- In order to participate in these calls, businesses must know of their existence, and they must have the time and resources to participate. This commonly results in a bias toward larger businesses with the ability to dedicate resources to government



## STRENGTHENING POST-HURRICANE SUPPLY CHAIN RESILIENCE

interactions. It also means that only issues identified by participants were addressed, so issues affecting small to mid-sized businesses did not always surface. Smaller organizations also noted that the calls can be “intimidating” to join because everyone seems to already understand the flow of the call.

- An additional challenge regarding government-hosted coordination and information-sharing platforms was the concern over Freedom of Information Act and sunshine laws. Businesses are often reluctant to share confidential information that could become public—even if this information is critical for government understanding of why particular interventions may be necessary.

Other key platforms used during the 2017 hurricane season included the following:

- In-person meetings, such as those affiliated with the creation of the Puerto Rico Business Emergency Operations Center, allowed for a more conversational atmosphere, where issues and solutions could be raised concurrently. While convened by FEMA, participants self-organized into segments that did not necessarily align with emergency support function, lifeline, or critical infrastructure structures. This allowed them to focus on issues the group considered most critical, rather than those presented to them from an outsider’s perspective.
- Sector- and industry-specific phone conferences as well as problem-specific task forces were utilized to focus on challenges affecting a particular business segment or issues that benefit from expert knowledge. This included groups dedicated to the restoration of power and groups focused on information and resource requirements for owners and operators of private sector supply chains. Both groups used a mix of in-person and virtual meeting methods to convene. Some of these groups were formed by government emergency management personnel, some were organized by industry subject-matter experts, and some were collaborative.
- Less formal communication and coordination mechanisms also existed, including person-to-person conversations via text, email, or phone. These were typically focused on specific issues or solutions for a single business or supply chain. Challenges with this format are that while the issues identified may be common to other businesses, the solutions were not necessarily shared broadly.
- Websites dedicated to sharing business status and/or information critical to business operations also served as tools for coordination during the 2017 events. As one example, a collaboration by the private sector committees of the National Emergency Management Association and the International Association of Emergency Managers, provided a map-based status snapshot of roads, power, and communications.<sup>18</sup>

<sup>18</sup> See <http://www.iaem.com/documents/IAEM-NEMA-Harvey-Tool-31Aug2017.pdf>.

(See also the RxOpen online platform operated by Healthcare Ready, discussed in Box 4.5.)

- Social media platforms are also a rich source of information (or misinformation) following a disaster. Groups such as Humanity Road monitor these platforms, follow trends, vet the data, and aggregate to provide reports of what those affected by the disaster are talking about.<sup>19</sup>
- Industry-specific groups such as the Port Coordination Team in Houston can also help to facilitate information flow and coordination. The team meets on an ongoing basis during normal operations in order to maintain relationships, and then changes to problem-specific mode during disasters. The established relationships allow the group to quickly ramp up discussions without the awkwardness of first getting to know one another. The group has already navigated the team-building process, and members quickly begin working together to address issues identified in the current emergency.

While each of these existing coordination mechanisms are valuable, collectively there are some common challenges that often arise. For instance, businesses with pre-existing relationships and connections to government emergency management structures are generally able to get their issues considered and resolved more easily than others. There can also be challenges of different engagement mechanisms competing for attention from the business community, with some private sector representatives being overwhelmed with requests to participate in calls at the state level, at the federal level, within their sector, and for a problem-specific task force. Thus, there needs to be ongoing consideration about how to advance this collective “ecosystem” for engagement in a way that minimizes the time burden placed on any individual participant.

Broader “whole community” coordination strategies can reduce the potential for gaps and/or confusing overlaps in coverage. Coordination needs to occur in a distributed fashion—involving stakeholders at lower levels, with direct first-hand knowledge of what problems are arising in the affected area; and those at higher levels, with the capacity to identify related adjacent issues that should be addressed in a coordinated manner—stakeholders with capacity for the type of system-scale understanding discussed under Recommendation 2.

Depending on the scale of the incident, the overall leadership of these coordination efforts could occur at the federal, state, or local level. At the federal level, leadership is likely to come from FEMA’s National Response Coordination Center and the local Business Emergency Operations Center. At the state level, it may come from a sector-specific agency or equivalent organization responsible for coordinating private sector support—perhaps with aid from state associations representing key sectors (e.g., fuel, convenience and grocery stores, utilities). Local-level emergency management (which is often limited in staff, physical operating spaces, and other resources) may need to draw upon staff from other agencies or external

---

<sup>19</sup> See <https://www.humanityroad.org/>.



## STRENGTHENING POST-HURRICANE SUPPLY CHAIN RESILIENCE

**Box 4.5****Healthcare Ready: Example of a Strong Coordinating Platform**

Healthcare Ready is a nonprofit organization that serves as an independent coordinating body (and the health care Information Sharing and Analysis Center) for disaster information for the medical and pharmaceutical industry—including key supply chain actors such as drug manufacturers and distributors; health care facilities and providers; federal agencies such as DHS, FEMA, and Department of Health and Human Services; and state and local governments. Its relationships with industry members, and its position as a neutral, nonprofit organization, allows it to be a trusted broker of information.

Healthcare Ready provides an industry-specific tool, RxOpen, to deliver information about the operating status of pharmacies for areas affected by disaster.<sup>9</sup> RxOpen is heavily used by the public to locate open pharmacies, by government officials and first responders to coordinate response and recovery efforts, and by the American Red Cross to ensure that people in shelters have access to pharmacies.

During the 2017 hurricane season, Healthcare Ready was activated over 70 days and mapped 16,536 pharmacies in nine states and territories, and also provided supply chain coordination, patient assistance, coordination of donations, and identification of medical supply manufacturer and distributor needs. It served as a key link in the information chain supporting patient care, and these connections led to many life-saving actions. Each storm presented unique challenges for the organization. For instance, during Hurricane Irma, it helped provide prescription and medical supplies for special needs shelters in the wake of massive evacuations. During Hurricane Harvey it coordinated helicopter delivery of supplies to hospitals given the widespread flooding that blocked normal truck deliveries. And during Hurricane Maria, it assisted with communicating the needs and challenges of drug and medical device manufacturers that were critical to national supply chains.

Figure 4.3 illustrates some key information about Healthcare Ready's 2017 season activities and shows an example of the RxOpen dashboard.

organizations with domain expertise, such as a local Chamber of Commerce. The lead organization in all the cases need not be responsible for providing solutions to all the problems arising, but should be able to maintain real-time awareness of all of the critical developments occurring at different levels within the affected jurisdictions.

**Recommendation 3. Support mechanisms for coordination, information sharing, and preparedness among supply chain stakeholders.**

Some key steps and strategies to advance this recommendation are to

- Ensure that emergency preparedness plans delineate clear roles and responsibilities.
- Strengthen industry interface with local, state, and federal agencies through efficient communication channels; coordinate plans for identifying, obtaining, pre-positioning,

## CONVEYANCE AND DISTRIBUTION OF CRITICAL RELIEF AND RECOVERY SUPPLIES

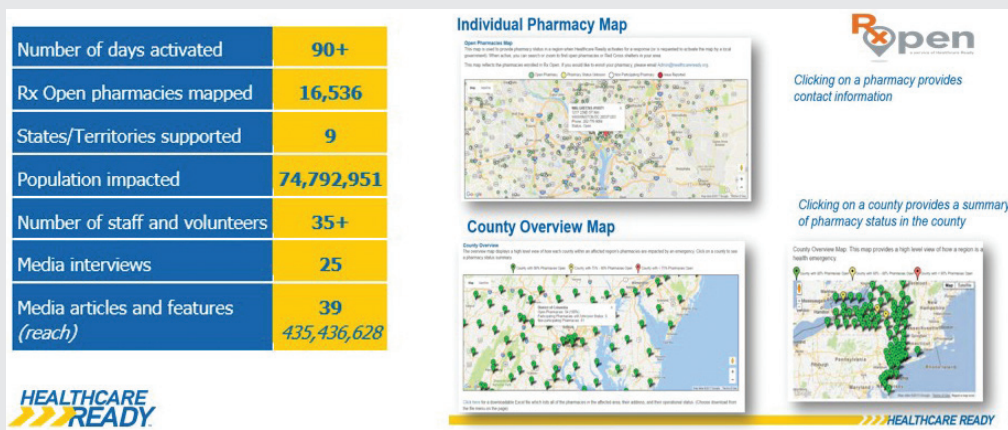

**Figure 4.3** Information from Healthcare Ready operations. Left: Healthcare Ready 2017 activation statistics. Right: Examples of the RxOpen dashboard.

SOURCES: <https://www.healthcareready.org/emergency-response/2017-responses>, and [https://www.healthcareready.org/system/cms/files/1583/files/original/Rx\\_Open\\_Mapping\\_Pharmacies\\_During\\_Disasters\\_webinar.pdf](https://www.healthcareready.org/system/cms/files/1583/files/original/Rx_Open_Mapping_Pharmacies_During_Disasters_webinar.pdf).

<sup>a</sup> See <https://www.healthcareready.org/rxopen>.

SOURCES: <https://www.healthcareready.org/>, and committee meeting presentation from Nicolette Louissaint, Executive Director, Healthcare Ready.

distributing, and securing resources (e.g., fuel, water, food, generators) during a disaster; and coordinate plans for ensuring adequate materials and equipment for response and recovery.

- Put supply contracts in place ahead of time, in particular for fuel and generators. (See Box 4.4.) Consider putting in place agreements with transportation companies, such as regional trucking companies, for the distribution of commodities.
- Plan for the fuel supply required for a large-scale evacuation and response, and ensure that adequate supplies are strategically positioned along evacuation routes.
- Develop plans to address the needs of workforce personnel and their families during disasters, including adequate backup human resources to address “personnel fatigue.”
- Educate public officials, policy makers, and response personnel on key lifeline-sector supply chains and how they work, to facilitate better decision making, help manage expectations, and foster effective response planning (discussed in the following section).

## STRENGTHENING POST-HURRICANE SUPPLY CHAIN RESILIENCE

- Create mutual aid agreements within lifeline sectors, such as those established by the electric utility industry, the water and wastewater agency response network, and the association of state and territorial health care officials.<sup>20</sup> Ensure that all participants have a common understanding of policies, authorities, and procedures (including those for personnel security and credentialing).<sup>21</sup>
- Establish a dedicated private sector liaison in each state and regional emergency management agency, to engage with businesses year-round.
- Encourage private sector entities to subscribe to the DHS Homeland Security Information Network for accessing the Emergency Services portal (and to join available state, regional, national Business Emergency Operations Center platforms) to obtain the latest information and situational awareness of ongoing events.
- Establish local community partnerships among local emergency management entities and local nongovernmental organizations and community groups that have established networks and relationships with individuals who need services (e.g., Meals on Wheels, adult daycare programs, faith-based organizations), for help with identifying and supporting vulnerable households.
- Plan for the location of relief aid points of distribution, and make arrangements for local organizations and networks to staff them.
- Collect data on an area's disease and risk profiles, to aid planning decisions by emergency management agencies and organizations regarding what drugs to stockpile or bring to an affected area.

We emphasize that many of the actions listed above involve not only FEMA, but also state and local government agencies, nongovernmental organizations, and business and industry owners and operators.

#### 4.4 PROVIDING ESSENTIAL TRAINING

Most stakeholders engaged in emergency management traditionally come from governmental organizations such as the military, law enforcement, fire service, or other federal or

---

<sup>20</sup> Edison Electric Institute: <http://www.eei.org/issuesandpolicy/electricreliability/mutualassistance/Pages/default.aspx>; American Water Work Association: <https://www.awwa.org/Portals/0/AWWA/Government/HarveyIrmaAARFINAL.pdf>; Association of State and Territorial Health Officials: <http://www.astho.org/Programs/Preparedness/Public-Health-Emergency-Law/Emergency-Authority-and-Immunity-Toolkit/Mutual-Aid-and-Assistance-Agreements-Fact-Sheet/>.

<sup>21</sup> An example of a successful mutual aid is the All Hazards Consortium's 'Multi-State Fleet Response' Working Group. The working group expedites the movement of private sector repair and supply chain fleets and resources across state borders in response to disasters, dealing primarily with power restoration. Sector/lifeline-specific information is compiled by an independent organization, and organization members make decisions on how best to restore their lifeline/sector activities by supporting one another.

state agencies, and they typically have had little to no engagement or employment with private sector entities. They likewise have little or no training specifically about the complexities of modern private sector supply chain systems or to understand the ways in which disasters, and disaster response actions, can affect those supply chains.

A newer generation of emergency management professionals has emerged from the scores of colleges and universities offering degrees and certificates in emergency management or homeland security—many established after the September 11, 2001, terrorist attacks. Yet even in these programs there is a need for more classes that provide the insights necessary to understand how disasters and emergency management strategies can impact supply chains and the economy as a whole.

To rectify this situation, education and training should be provided to emergency managers and those supporting operations in a disaster environment (e.g., Emergency Operations Center personnel, incident management teams, federal coordinating officers, and people staffing emergency support functions from other government agencies), to help all of these critical stakeholders evaluate the decisions they are making in a broader context. FEMA's Supply Chain Resilience Guide (see Chapter 5) does in fact advise just this sort of training.

This educational process could cover many of the basic supply chain concepts that are discussed in Chapter 2 of this report, along with the following types of content:

- an overview of private sector and nonprofit supply chains for key commodities, and their interdependencies;
- an analysis of the critical infrastructure sectors supporting supply chains, such as transportation; electricity generation and transmission; communication technologies; fuel refining, storage, and delivery; municipal water supply and wastewater; and financial systems;
- an overview of the ways that disasters can impact tax structures and other revenue sources at the federal, state, and local levels;
- a review of how the laws and regulations governing disaster operations can impact supply chains (e.g., price gouging laws, restrictions on governmental support for private sector organizations);
- an awareness of the human resources (staffing levels and types) necessary to support supply chains and supporting industries and activities (such as transportation or housing).

These training programs should also provide participants with the ability to analyze the following:

- the main economic drivers within their jurisdiction and the ways their actions and outputs can affect regional or national economic dynamics;

## STRENGTHENING POST-HURRICANE SUPPLY CHAIN RESILIENCE

**Box 4.6****Anticipating Societal and Technological Developments That May Impact Supply Chains**

In today's world rapid change is the norm, both in terms of constantly evolving technologies and in new social patterns and trends. Many of these changes have implications for how supply chains operate and for how individuals, communities, and businesses are impacted by and respond to disasters such as hurricanes. For instance, when Hurricane Irma caused mass evacuations in Florida, the traditional emergency management focus on ensuring gasoline supplies along evacuation routes was not matched by equal concern about ensuring that people driving electric vehicles had access to charging stations along these routes.<sup>a</sup> Also during Irma, people turned to mobile apps like never before for finding and sharing information about gas availability, road closures, traffic jams, weather updates, wireless hotspots, and public shelters. Such developments create both new opportunities and new challenges for emergency management.

One of the most rapidly evolving sectors of the U.S. economy is transportation and mobility. The National Academies' Transportation Research Board report *Critical Issues in Transportation 2019* (NASEM, 2018) identifies numerous developments that are expected to arise 10 to 20 years into the future. Among the many trends highlighted, the following are some examples that could be particularly important with respect to supply chains and disaster response:

- App-based services, including transportation services such as Uber and Lyft, are providing new options for consumers. These services are used not only for passenger travel but also sometimes for freight. The "Uberization" of last-mile deliveries and a greater dependence upon gig workers may have implications for driver availability in the aftermath of a disaster incident for delivery of critical supplies.
- demographic and economic data that can inform decisions about priorities for restoration assistance to different private sector and nonprofit supply chains;
- the ways that different supply chain disruptions can impact economic conditions, locally and at higher levels (e.g., damage to fuel refineries, ports, or airports or flooding that affects businesses, local agriculture, tourist areas, and attractions);
- the cost of disaster response or mitigation actions versus the costs of not taking those actions (e.g., the cost of providing generator fuel to a grocery store versus the cost of providing emergency food and water to individuals who would have otherwise purchased those supplies at that store);
- considerations involved in balancing efforts to protect critical supply chain interests (e.g., a manufacturing facility of national importance) with efforts to meet immediate humanitarian needs in the affected area;
- societal and technical developments that can affect the dynamics of supply chains for particular commodities or locations (see Box 4.6).

- The use of automated vehicles in freight delivery may move ahead faster than in passenger transportation because of safety, private incentives, and competitive pressures. Automated vehicles may (at least initially) prove to be less adaptable and resilient in disaster situations.
- If vehicles used for package delivery shift toward drones that fly packages to suburban and rural areas and robots that operate on urban streets and sidewalks, storm-related damage to critical infrastructure (e.g., Internet) may undermine operating continuity of such technologies.
- Increasing consumer preferences for direct and same-day delivery may have a couple of distinct effects. It may create enormous demand on “curb” capacity and contention between freight and passenger vehicle access in urban areas, and the diminished presence of traditional neighborhood retail outlets may continue in many areas, making it more difficult for residents to obtain critical supplies locally.
- Electrification of freight movement is likely to result from improved batteries and fuel cells, especially for local deliveries. This means that overall electric grid resilience in emergencies will be increasingly important, along with the rapid recovery of charging infrastructure.

Over the past few decades, the emergence of “big box” retailers dramatically impacted the sophistication of supply chains. Changes coming in the next few decades will be equally profound and are likely to both positively and negatively impact underlying supply chain resilience. FEMA and other agencies involved in emergency preparedness and response need to develop capacity to follow and even anticipate critical social, technological, and marketplace developments; consider possible implications for their operations; and prepare accordingly.

---

<sup>a</sup> In response to this lesson learned, the state of Florida is developing an electric vehicle road map that will include the locations of charging stations along evacuation routes.

This material could be provided to critical audiences through a variety of platforms and delivery methods, including:

- new courses in college emergency management programs focused on supply chain dynamics (e.g., vulnerabilities, impacts, restoration strategies);
- orientation training provided to new emergency managers, critical Emergency Operations Center staff and stakeholders, and newly elected government officials;
- in-person and online FEMA training classes—for law enforcement, fire department, and military officials who will be active in disaster operations; for FEMA incident management teams, federal coordinating officers, and regional operations; and for governmental budget and revenue personnel at all levels of government;
- “just-in-time” training provided to Emergency Operations Center personnel, with specific information tailored to address the disaster at hand (e.g., for a flood in Houston, consider the impacts of shutting down refineries shortly before Labor Day).

## STRENGTHENING POST-HURRICANE SUPPLY CHAIN RESILIENCE

Section 4.2 discussed the need for information collection and analysis frameworks that allow decision makers to assess the local, state, and national impacts of supply chain interruptions under a variety of possible scenarios. Developing these frameworks and analysis methodologies is important not only for direct operational application but also for education and training purposes. This sort of training could help decision makers evaluate complex questions such as the following:

- What are the life safety implications of this incident at the local, state/tribal/territorial, and national levels?
- What are the *direct* economic impacts of different courses of action in a given situation? For example, what is the cost to rectify the problem, and who might cover these costs? What is the cost of not correcting the situation? (For instance, if the grocery store closes because it does not have fuel, how much will it cost for the government to provide food and water for affected citizens?)
- What are the *indirect* economic impacts of different courses of action in a given situation? What is the potential loss of revenue at each jurisdictional level if the situation is not rectified? (For instance, if a bridge to a barrier island is not opened during tourist season, there are potential losses of revenue from local and state sales taxes, property taxes, and state and federal income taxes.) What is the compounding economic impact if a particular resource or facility is disrupted? (For instance, the loss of a saline manufacturing facility will lead to a delay in medical procedures, potentially causing dire medical situations and higher medical bills paid by private and government insurance.)
- What organization, at what level, has the most appropriate, timely, and cost-effective resources to rectify a given disruption?

This level of attention to macro- and microeconomic conditions during disasters, while not traditional, is entirely appropriate for emergency management training, given that elected officials and the public often demand accountability for ensuring that disaster response resources are optimally utilized.

These training activities can be highly complementary to the activities discussed in earlier recommendations—accomplishing several important goals simultaneously. For instance, expert-led workshops and courses can be planned both to train participants about basic supply chain concepts and to help the participants evaluate the actual supply chain dynamics and supporting infrastructures within their own jurisdictions—thus advancing the system-scale understanding discussed under Recommendation 2. Likewise, these training activities can be valuable opportunities for informal engagement between emergency management officials and key players in local and regional supply chain operations, who can share insights beyond just the generic operational information covered in formal trainings. As discussed under



Recommendation 3, this type of relationship-building has benefits beyond simple knowledge transfer; it can help build a level of personal comfort and trust that makes it far easier for people to work together under stressful disaster response conditions.

**Recommendation 4. Develop and administer training on supply chain dynamics and best practices for private-public partnerships that enhance supply chain resilience.**

Some key steps and strategies to advance this recommendation are to

- Provide all stakeholders engaged in emergency management of disasters with at least a base level of training about supply chain dynamics, and provide senior decision makers, elected officials, and governmental financial officers with advanced training that focuses on the economic impacts of disasters—all phases, not just recovery.
- Provide private and nonprofit entities access to training that fosters understanding of needs and opportunities to engage with government organizations in disaster preparation and response.
- Advance development of processes, data, and models to support decision making related to supply chains during disaster operations.





## 5

## The Federal Emergency Management Agency's Current Progress, Opportunities, and Challenges

In recent years, FEMA has signaled a tremendous commitment to build “a culture of preparedness” through its insurance, mitigation, preparedness, continuity, and grant programs. To this end, several new and ongoing efforts have been established or strengthened, and a new Strategic Plan set forth in 2018 highlights several key areas to advance the agency’s mission and make the nation more resilient (see below). The 2017 *Hurricane After Action Report* completed for hurricanes Harvey, Irma, and Maria further reinforced the need for FEMA to take a more strategic approach to addressing supply chain resilience—including the need for better understanding of, and relationships with, the private sector and critical infrastructure sectors (FEMA, 2018a). This National Academies report supports these goals and provides recommendations to enhance the effective, efficient integration of capabilities and planning among diverse supply chain stakeholders and critical government entities.

### 5.1 KEY ADVANCES

Below is an overview of some of the other advances being made by FEMA that hold potential to contribute to the goals of supply chain resilience.

- **FEMA 2018–2022 Strategic Plan.** In 2018, FEMA released a new five-year strategic plan that outlines three strategic goals: (i) build a culture of preparedness, (ii) ready the nation for catastrophic disasters, and (iii) reduce the complexity of FEMA. Under the plan’s second goal, section 2.3 speaks directly to the issue of supply chain resilience to “posture FEMA and the whole community to provide life-saving and life-sustaining commodities, equipment, and personnel from all available sources” (FEMA, 2018b). FEMA makes clear that the agency has a growing interest

## STRENGTHENING POST-HURRICANE SUPPLY CHAIN RESILIENCE

in helping to ensure that communities have robust, adaptable supply chains that can withstand the stresses of extreme weather events, noting:

The most effective way to deliver the needed supplies to a disaster-impacted area is by re-establishing pre-disaster supply chains. Building resilience within these systems and providing for their rapid restoration is key to responding to any catastrophic incident. FEMA will work with the private sector and federal partners to build a shared understanding of supply chain vulnerabilities and the ways FEMA can work with its partners to rapidly restore these critical flows.

This transition signals that FEMA is thinking more strategically and systematically in addressing supply chain needs following disasters and in establishing new relationships and mechanisms for working with diverse partners in advance of a catastrophic event.

- **Supply Chain Resilience Guide.** FEMA has published a *Supply Chain Resilience Guide* to help leaders and practitioners in emergency management around the country better understand supply chains in their own jurisdictions. Specifically, “this document presents an approach to assist emergency managers with analyzing local supply chains and enhancing supply chain resilience” (FEMA, 2019b). As part of this guide, FEMA provides foundational information to help readers understand how supply chains are structured and the roles that emergency managers can take in promoting supply chain resilience. It suggests a process by which emergency managers can approach mapping and assessing supply chains in their region and engage with relevant stakeholder groups, and it discusses how this better understanding can inform logistics planning.
- **National Response Framework Update and New Emergency Support Function #14 (ESF14).** FEMA recently updated the 2008 National Response Framework to include what was learned from the hurricanes and wildfires in 2017. As part of this update, FEMA has established a new emergency support function, ESF14, which “supports the coordination of cross-sector operations, including stabilization of key supply chains and community lifelines, among infrastructure owners and operators, businesses, and their government partners” (FEMA, 2019a) The primary focus of ESF14 is two-fold:
  - assessment, analysis, and situational awareness, such as supporting cross-sector planning, using modeling and simulation to better understand and identify critical infrastructure or supply nodes, ensuring that organizations are provided good information for decision making, and sharing information on the status and needs of critical infrastructure and the private sector supply chains
  - operational coordination, including evaluating private sector offers of materials or technical assistance, aligning government efforts with business and private sector activities, and coordinating assistance of short- and long-term restoration activities

- **Disaster Recovery Reform Act.** The 2018 Disaster Recovery Reform Act mandated numerous relevant reforms and changes to FEMA processes. Of particular relevance is the establishment of the National Public Infrastructure Pre-Disaster Hazard Mitigation fund.<sup>1</sup> This program requires FEMA to set aside up to 6 percent of the money it spends on disaster relief for local projects aimed at improving community resilience and to reduce the likelihood of damage during future disasters. The new program, known as Building Resilient Infrastructure and Communities, is currently under development and undergoing a public comment and information-gathering process at the time of this writing.
- **Emergency Management Performance Grants.** In 2019, recipients of funding from Emergency Management Performance Grants will be required to develop and maintain a distribution management plan as an addition to their emergency operations plan, which “includes end-to-end commodity and resource management; warehouse and transportation operations to effectively and efficiently distribute supplies to distribution points and staging areas; provision of equipment and services to support incident requirements; and a mechanism for supplies and commodities to be provided to survivors.”<sup>2</sup> This plan will assist FEMA regional offices in assessing the types of resources and information they need to have in place to respond to different types of events. FEMA recently provided guidance on the key areas that must be addressed as part of developing this plan. Ideally, this program should align with the committee’s recommendation for prioritizing restoration of an area’s regular supply chains over expansion of replacement and relief supply chains.
- **National Business Emergency Operations Center.** The National Business Emergency Operations Center, discussed in Chapter 4, is another important evolving effort by FEMA to actively engage private sector stakeholders in preparedness, policy, training exercises, and response activities and to enhance communication, collaboration, and exchange of information for response and recovery.
- **Supply Chain Analysis Network.** FEMA’s Logistics Management Directorate under the Office of Response and Recovery has recently expanded its supply chain analysis capabilities through the Supply Chain Analysis Network. This network is a contracted team that can provide insight on the private sector supply chain landscape to inform FEMA decision-making processes in disaster response operations.<sup>3</sup> The Supply Chain Analysis Network will be able to provide (i) rapid-response “ecosystem assessments” of a designated area’s inbound and outbound flow, principal nodes, links and/or channels, and critical dependencies; and (ii) regularly updated

---

<sup>1</sup> See <https://www.fema.gov/disaster-recovery-reform-act-2018>.

<sup>2</sup> See <https://www.fema.gov/media-library/assets/documents/178513>.

<sup>3</sup> The team draws expertise from Dewberry, the Massachusetts Institute of Technology, the Center for Naval Analysis, and the American Logistics Aid Network.

*STRENGTHENING POST-HURRICANE SUPPLY CHAIN RESILIENCE*

“lifelines assessments” that provide more detail on individual flows, network behavior, and observed changes. The ecosystem assessment synthesizes a strategic view, while the lifelines assessment analyzes operational progress. This capability integrates with FEMA’s Business, Industry, and Infrastructure Integration Office (formerly the FEMA Private Sector Division).

**5.2 THE LARGER POLITICAL AND POLICY CONTEXT**

FEMA is making a number of important strides in advancing the goals of supply chain resilience, as evidenced by the activities outlined above. Yet the committee also recognizes that these efforts to advance new programs and to work with new partners are both shaped and constrained by the larger policy context in which FEMA operates. For instance, the agency’s efforts must align with the Stafford Act and other legislative statutes that mandate FEMA’s authorities and responsibility for responding to disasters. The opportunities to collect and share some information useful for supply chain analyses (e.g., regarding fuel sales in a given region) are constrained by anti-trust laws designed to increase competition and reduce collusion. These broader policy issues fall outside of the scope of our study and thus are not discussed in greater depth here. It is important to acknowledge, however, that these broader policy frameworks do influence how FEMA can pursue some of the recommendations made herein, and lawmakers may wish to consider whether such constraints need to be addressed.

**5.3 CRITICAL LEADERSHIP ROLES FOR FEMA**

Emergency management always entails a complex interplay among numerous federal, state, and local officials and agencies, working in concert with representatives of key private sector entities, nongovernmental organizations, and community organizations. The specific roles and responsibilities undertaken by each of these stakeholders will vary by location, scope, complexity, and type of hazard being addressed. Therefore, we avoid being too prescriptive in terms of dictating who would enact all of the different actions recommended.

Many state and local emergency management offices do in fact have significant capabilities to lead some of these recommended actions for strengthening supply chain resilience. Yet during active response operations, they can face constraints in terms of access to certain critical information and in terms of information sharing among states or among counties and communities within a state. Some smaller state and local offices can also face practical constraints in terms of staffing resources and physical operating space for an Emergency Operations Center (which, for instance, can limit capacity for face-to-face cooperation with private sector representatives).

FEMA has unique capabilities in terms of operational resources, reservoirs of experience, and cross-jurisdictional scope, and thus the agency is well placed to provide operational

assistance to governors and mayors across the country—in particular for addressing supply chain issues that cross municipal or state borders, or that have national or global implications. For instance, this may include technical assistance for collecting data and mapping critical assets, linkages, and interdependencies within a region; advancing preparedness and mitigation strategies to reduce vulnerabilities identified in these analyses; and strengthening coordination with the private sector and nongovernmental organization stakeholders that play important roles in meeting the basic needs of populations affected by a disaster.

While FEMA itself cannot be responsible for carrying out all of these activities, it can provide leadership in convening, coordinating, and empowering others—going beyond just administering grant programs to also provide hands-on guidance for increasing understanding and building capacity.

## 5.4 CONCLUSION

Many valuable lessons were learned from the experiences of the historic 2017 hurricane season. These insights, coupled with political will and strategic management, provide a unique opportunity to transform the way that FEMA and its many partners think about and interact with the critical supply chains upon which we all depend.

The 2017 hurricane season posed tremendous challenges to FEMA and other emergency management partners in responding to the widely dispersed and unprecedented impacts of Hurricanes Harvey, Irma, and Maria (simultaneously with other major disasters such as western wildfires). FEMA has a vital role in disaster response—to save lives, to reassure a traumatized public, and to maintain critical operations. But focusing these efforts as much as possible on strategic interventions that help quickly restore normal economic activity has the dual advantage of getting people's lives back to normal more quickly, while freeing up FEMA's valuable resources and capacity for responding to the next event. By working together with businesses, state and local governments, the health care industry, and others—in a “whole of community” effort—FEMA can help advance more widespread preparedness that reduces supply chain vulnerabilities. The more advances that are made on these fronts, the less time, energy, and resources will be needed for response and recovery.

Some important steps toward meeting these goals are already underway; further advances will require ongoing outreach to both private and public sector stakeholders to make the case that preparedness and rapid recovery are in everyone's best interest. It is not possible to prevent hurricanes or other natural hazards, but with the right kinds of preparations, information systems, and strategic partnerships, prolonged disasters can be reduced and become more of a rarity.



## References

- Alderson, D. L. 2008. Catching the “Network science” bug: Insight and opportunity for the operations researcher. *Operations Research* 56(5): 1047–1065. doi: 10.1287/opre.1080.0606.
- API (American Petroleum Institute). 2016. *Oil and natural gas: Industry preparedness handbook*. Washington, DC. <https://www.api.org/~media/Files/Policy/Safety/ONG-Industry-Preparedness-Handbook-v2.pdf> (accessed November 21, 2019).
- Börner, K., S. Sanyal, and A. Vespignani. 2007. Network science. *Annual Review of Information Science and Technology* 41(1): 537–607. doi: 10.1002/aris.2007.1440410119.
- Bruneau, M., S. Chang, R. Eguchi, G. Lee, T. O’Rourke, A. Reinhorn, M. Shinozuka, K. Tierney, W. Wallace, and D. Winterfeldt 2003. A framework to quantitatively assess and enhance the seismic resilience of communities. *Earthquake Spectra* 19(4): 733–752.
- Çelik, M., Ö. Ergun, B. Johnson, P. Keskinocak, A. Lorca, P. Pekgun, and J. Swann. 2012. Humanitarian logistics. In *Tutorials in operations research: New directions in informatics, optimization, logistics, and production*, edited by P. B. Mirchandani. Hanover: INFORMS.
- Çelik, M., Ö. Ergun, and P. Keskinocak. 2015. The post-disaster debris clearance problem under incomplete information. *Operations Research* 63(1). doi: 10.1287/opre.2014.1342.
- DHS (Department of Homeland Security). 2016. *Critical infrastructure threat information sharing framework: A reference guide for the critical infrastructure community*. Washington, DC. <https://www.dhs.gov/sites/default/files/publications/ci-threat-information-sharing-framework-508.pdf> (accessed November 21, 2019).
- Doroudi, R., R. Azghandi, Z. Feric, O. Mohaddesi, Y. Sun, J. Griffin, O. Ergun, D. Kaeli, P. Sequeira, S. Marsella, and C. Harteveld. 2018. An integrated simulation framework for examining resiliency in pharmaceutical supply chains considering human behaviors. Presented at 2018 Winter Simulation Conference: Simulation for a Noble Cause, Gothenburg, Sweden, December 9-12.
- Duran, S., M. A. Gutierrez, and P. Keskinocak. 2011. Pre-positioning of emergency items for CARE International. *INFORMS Journal on Applied Analytics* 41(3): 223–237. doi: 10.1287/inte.1100.0526.
- EEI (Edison Electric Institute). 2014. *Before and after the storm: A compilation of recent studies, programs, and policies related to storm hardening and resiliency*. Washington, DC. <http://www.eei.org/issuesandpolicy/electricreliability/mutualassistance/Documents/Before%20and%20After%20the%20Storm.pdf> (accessed November 21, 2019).
- Ergun, Ö., G. Karakus, P. Keskinocak, J. Swann, and M. Villarreal. 2011. Operations research to improve disaster supply chain management. In *Wiley encyclopedia of operations research and management science*, edited by J. J. Cochran, L. A. Cox, P. Keskinocak, J. P. Kharoufeh, and J. C. Smith. Hoboken, NJ: John Wiley and Sons, Inc.
- FCC (Federal Communications Commission). 2018. *Report on the 2017 Atlantic hurricane season’s impact on communications*. Washington, DC. <https://www.fcc.gov/document/2017-atlantic-hurricane-season-report-impact-communications> (accessed November 21, 2019).



## STRENGTHENING POST-HURRICANE SUPPLY CHAIN RESILIENCE

- FEMA (Federal Emergency Management Agency). 2018a. *2017 Hurricane season FEMA after-action report*. Washington, DC. <https://www.fema.gov/media-library-data/1533643262195-6d1398339449ca85942538a1249d2ae9/2017FEMAHurricaneAARv20180730.pdf> (accessed November 21, 2019).
- FEMA. 2018b. *2018–2022 strategic plan*. Washington, DC. [https://www.fema.gov/media-library-data/1533052524696-b5137201a4614ade5e0129ef01cbf661/strat\\_plan.pdf](https://www.fema.gov/media-library-data/1533052524696-b5137201a4614ade5e0129ef01cbf661/strat_plan.pdf) (accessed November 21, 2019).
- FEMA. 2019a. *Emergency support function #14: Cross-sector business and infrastructure*. Washington, DC. [https://www.fema.gov/media-library-data/1572358162675-d2c7af34a5b5063e582ae1798b038351/ESF14AnnexFINAL508c\\_20191028.pdf](https://www.fema.gov/media-library-data/1572358162675-d2c7af34a5b5063e582ae1798b038351/ESF14AnnexFINAL508c_20191028.pdf) (accessed November 21, 2019).
- FEMA. 2019b. *Supply chain resilience guide*. Washington, DC. <https://www.fema.gov/media-library-data/1555328671083-d9422177bd55d9c6fafc327a6b239290/SupplyChainResilienceGuide-April2019.pdf> (accessed November 21, 2019).
- Hansen, M., P. Howd, A. Sallenger, and J. Lillycrop. 2007. Estimation of post-Katrina debris volume: An example from coastal Mississippi. In *Science and the storms: The USGS response to the hurricanes of 2005*, edited by G. S. Farris, G. J. Smith, M. P. Crane, and C. R. Demas. Washington, DC: Department of the Interior.
- Havas, C., B. Resch, C. Francalanci, B. Pernici, G. Scalia, J. L. Fernandez-Marquez, T. V. Achte, G. Zeug, M. R. Mondardini, D. Grandoni, B. Kirsch, M. Kalas, V. Lorini, and S. Rüping. 2017. E2mC: Improving emergency management service practice through social media and crowdsourcing analysis in near real time. *Sensors (Basel)* 17(12): 2766. doi: 10.3390/s17122766.
- Holguín-Veras, J., M. Jaller, L. N. V. Wassenhove, N. Pérez, and T. Wachtendorf. 2014a. Material convergence: Important and understudied disaster phenomenon. *Natural Hazards Review* 15(1): 1–12. doi: 10.1061/(ASCE)NH.1527-6996.0000113.
- Holguín-Veras, J., E. Taniguchi, M. Jaller, F. Aros-Vera, F. Ferreira, and R. G. Thompson. 2014b. *The Tohoku disasters: Chief lessons concerning the post disaster humanitarian logistics response and policy implications*. Transportation Research Part A. Elsevier.
- HSIN (Homeland Security Information Network). 2019. *2018 annual report*. Washington, DC: Department of Homeland Security. <https://www.dhs.gov/publication/hsin-documents> (accessed November 21, 2019).
- ISER (Infrastructure Security and Energy Restoration). 2017. *Tropical storm Harvey event report*. Washington, DC: Department of Energy, Office of Electricity Delivery and Energy Reliability. [https://www.energy.gov/sites/prod/files/2017/10/f37/Hurricane%20Harvey%20Event%20Summary%20%239\\_0.pdf](https://www.energy.gov/sites/prod/files/2017/10/f37/Hurricane%20Harvey%20Event%20Summary%20%239_0.pdf) (accessed November 21, 2019).
- ISER. 2018. *State, local, tribal, and territorial energy assurance: 2017 year in review*. Washington, DC: Department of Energy, Office of Electricity Delivery and Energy Reliability. <https://www.energy.gov/sites/prod/files/2018/03/f50/SLTT%20Energy%20Assurance%202017%20Year%20in%20Review.pdf> (accessed November 21, 2019).
- Kotsireas, I. S., A. Nagurney, and P. M. Pardalos, eds. 2018. *Dynamics of disasters: Algorithmic approaches and applications*. Basel, Switzerland: Springer International.
- Lorca, Á., M. Çelik, Ö. Ergun, and P. Keskinocak. 2017. An optimization-based decision-support tool for post-disaster debris operations. *Production and Operations Management* 26(6): 1076–1091. doi: 10.1111/poms.12643.
- Mazer-Amirshahi, M., and E. R. Fox. 2018. Saline shortages: Many causes, no simple solution. *New England Journal of Medicine* 378: 1472–1474. <https://www.nejm.org/doi/full/10.1056/NEJMp1800347> (accessed November 21, 2019).
- Mendonça, D., and W. A. Wallace. 2004. Studying organizationally situated improvisation in response to extreme events. *International Journal of Mass Emergencies and Disasters* 22(2): 5–29.
- Mendonça, D. J., and W. A. Wallace. 2007. A cognitive model of improvisation in emergency management. *IEEE Transactions on Systems, Man, and Cybernetics, Part A: Systems and Humans* 37(4): 547–561. doi: 10.1109/tsmca.2007.897581.
- NASEM (National Academies of Sciences, Engineering, and Medicine). 2018. *Critical issues in transportation 2019*. Washington, DC: The National Academies Press. doi: <https://org/10.17226/25314>.

- NASEO (National Association of State Energy Officials). 2018. *Guidance for states on petroleum shortage response planning*. Arlington, VA. <https://www.naseo.org/Data/Sites/1/petroleum-guidance/final-naseo-petroleum-guidance-feb-2018.pdf> (accessed November 21, 2019).
- NPC (National Petroleum Council). 2014. *Enhancing emergency preparedness for natural disasters government and oil and natural gas industry actions to prepare, respond, and recover*. Washington, DC. [https://www.npc.org/reports/NPC\\_EmPrep\\_Report\\_2014-12-18.pdf](https://www.npc.org/reports/NPC_EmPrep_Report_2014-12-18.pdf) (accessed August 13, 2019).
- Nurre, S. G., B. Cavdaroglu, J. E. Mitchell, T. C. Sharkey, and W. A. Wallace. 2012. Restoring infrastructure systems: An integrated network design and scheduling (INDS) problem. *European Journal of Operational Research* 223(3):794-806. doi: <https://org/10.1016/j.ejor.2012.07.010>.
- OEDER (Office of Electricity Delivery and Energy Reliability). 2010. *Hardening and resiliency: U.S. energy industry response to recent hurricane seasons*. Washington, DC: Department of Energy.
- OIG (Office of Inspector General). 2011. *FEMA's oversight and management of debris removal operations OIG-11-40*. Washington, DC: Department of Homeland Security. [https://www.oig.dhs.gov/sites/default/files/assets/Mgmt/OIG\\_11-40\\_Feb11.pdf](https://www.oig.dhs.gov/sites/default/files/assets/Mgmt/OIG_11-40_Feb11.pdf) (accessed August 13, 2019).
- Palin, P. J. 2018. Learning from H.I.M. (Harvey, Irma, Maria): Preliminary impressions for supply chain resilience. *Homeland Security Affairs* 14, Article 7. <https://www.hsaj.org/articles/14598> (accessed November 21, 2019).
- Palin, P. J., L. S. Hanson, D. Barton, and A. Frohwein. 2018. *Supply chains and the 2017 hurricane season: A collection of case studies about Hurricanes Harvey, Irma, and Maria and their impact on supply chain resilience*. Arlington, VA: CNA Analysis and Solutions.
- Peters, K., H. Fleuren, D. den Hertog, M. Kavelj, S. Silva, R. Goncalves, O. Ergun, and M. Soldner. 2019. The nutritious supply chain: Optimizing humanitarian food aid. *Operations Research* [submitted].
- Quarantelli, E. L. 2006. *Catastrophes are different from disasters: Some implications for crisis planning and managing drawn from Katrina. Insights from Social Sciences*, June 11. <https://items.ssrc.org/understanding-katrina/catastrophes-are-different-from-disasters-some-implications-for-crisis-planning-and-managing-drawn-from-katrina/> (accessed November 21, 2019).
- Ulusan, A., and Ö. Ergun. 2018. Restoration of services in disrupted infrastructure systems: A network science approach. *PLOS One*. doi: [10.1371/journal.pone.0192272](https://doi.org/10.1371/journal.pone.0192272).
- USVI HRRTF (USVI Hurricane Recovery and Resilience Task Force). 2018. *USVI Hurricane Recovery and Resilience Task Force: Report 2018*. St. Thomas, VI. [https://first.bloomberglp.com/documents/257521\\_USVI\\_Hurricane+Recovery+Taskforce+Report\\_DIGITAL.pdf](https://first.bloomberglp.com/documents/257521_USVI_Hurricane+Recovery+Taskforce+Report_DIGITAL.pdf) (accessed November 21, 2019).
- Walker, D. T. 2017. The 2017 hurricane season: A review of emergency response and energy infrastructure recovery efforts. Statement of the chair of the Public Utility Commission of Texas before the U.S. House of Representatives Committee on Energy and Commerce Subcommittee on Energy. November 2. <https://docs.house.gov/meetings/IF/IF03/20171102/106573/HHRG-115-IF03-Wstate-WalkerD-20171102.pdf> (accessed November 21, 2019).
- WFP (World Food Programme). 2017. *2016 WFP supply chain annual report*. Rome, Italy. <https://docs.wfp.org/api/documents/WFP-0000068358/download> (accessed November 21, 2019).
- Xian, S., N. Lin, and A. Hatzikyriakou. 2015. Storm surge damage to residential areas: A quantitative analysis for Hurricane Sandy in comparison with FEMA flood map. *Natural Hazards* 79(3): 1867-1888. doi: [10.1007/s11069-015-1937-x](https://doi.org/10.1007/s11069-015-1937-x).



# Appendix A

## Speakers from the Committee Meetings

### **MEETING 1: WASHINGTON DC; JUNE 26, 2018**

- Jeff Dorko, Assistant Administrator for Logistics, Office of Response and Recovery, FEMA
- Phil Palin and David Kauffman, CNA

### **MEETING 2: SAN JUAN, PUERTO RICO; AUGUST 15-17, 2018**

- Scott Erickson, Logistics Chief, FEMA
- Darrell Ransom, Logistics Management Directorate, FEMA
- Jarrod Goentzel, Massachusetts Institute of Technology Center for Transportation and Logistics
- Philip Palin, Principal Investigator, Institute for Public Research, CNA
- Maria Virella, President, WorldNet
- Hector Pesquera, Secretary of the Department of Public Safety
- Carlos Acevedo, Acting Commissioner, Puerto Rico Emergency Management Agency
- Luis Cruz Ramirez, Puerto Rico Emergency Management Agency
- Benjamin Nieves, CEO, ISP, Inc.
- Arodis Suazo, Security Manager, Claro
- Victor Dominguez, General Manager for Operations, Puma Energy
- Manuel Reyes, Executive VP, Chamber of Marketing, Industry and Food Distribution
- Jose Rivera, President, Professional Fuel Services
- Ramon Gonzalez, Chief Financial Officer, Empire Gas
- Hector Colon, Department of Health, Puerto Rico
- Angel Davila, President, Hospitals Coalition

*STRENGTHENING POST-HURRICANE SUPPLY CHAIN RESILIENCE*

**MEETING 3: HOUSTON, TX; OCTOBER 22-23, 2018**

- Mark Sloan, Harris County Emergency Management Coordinator
- Phil Palin, Lars Hanson, CNA
- John Benzon, Homeland Security Planner, Harris Co. Office of Emergency Management
- Justin Boutilier, Massachusetts Institute of Technology Humanitarian Supply Chain Lab, Center for Transportation and Logistics
- Steve Boyd, Senior Managing Director, Sun Coast Resources
- Buster Brown, Director of Scheduling and Shipper Relations, Colonial Pipeline Company
- George Buenik, Director, Mayor's Office for Public Safety and Homeland Security, City of Houston
- Colonel Kevin L. Cotman, Commander, Defense Logistics Agency (DLA) Energy Americas
- Jason C. Exum, Deputy Director, DLA Energy Americas
- Rick Flanagan, Emergency Management Coordinator, Office of Emergency Management, City of Houston
- Jarrod Goentzel, Director, Massachusetts Institute of Technology Humanitarian Supply Chain Lab, Center for Transportation and Logistics
- Brian Greene, President and CEO, Houston Food Bank
- Jeff Gunnulfson, Senior Director, Security and Risk Management Issues, American Fuel and Petrochemical Manufacturers
- Jack Hanagriff, Mayor's Office for Public Safety and Homeland Security, City of Houston
- Scott E. McHugh, Global Director, Crisis Management and Security, LyondellBasell Chemical Company
- Jackie Miller, Mayor's Office for Public Safety and Homeland Security, City of Houston
- Captain Steve Nerheim, Director, Vessel Traffic Service, Houston-Galveston Port Coordination Team, Port of Houston
- Jamie Padgett, Associate Professor of Civil Engineering, Rice University
- Chris Perkins, Deputy Emergency Management Coordinator, Office of Emergency Management, City of Houston
- Bert Sausse, Emergency Operations Coordinator, CenterPoint Energy
- Gene Shearer, Supply Chain Advisor, FEMA Logistics Directorate
- RJ Thomas, Coastal Bend Council of Governments
- Reginald Tuvilla, Emergency Management Response Team Member, Public Utility Commission of Texas
- Alexandra Woodruff, Business Strategy Advisor, FEMA Logistics Directorate

**FUEL WEBINAR, JANUARY 22, 2018**

- Susan Grissom, Chief Industry Analyst, American Fuel and Petrochemical Manufacturers
- Robert Benedict, Senior Director; Petrochemicals, Transportation, and Infrastructure; American Fuel and Petrochemical Manufacturers
- Amy Kalt, Manager of Analytical Services, Baker O'Brien, Inc.
- Jeff Gunnulfson, Senior Director, Security and Risk Management, American Fuel and Petrochemical Manufacturers

**MEETING 4: MIAMI, FL; JANUARY 29-30, 2019**

- Ned Bowman, Executive Director, Florida Petroleum Marketers Association
- Susan Grissom, Chief Industry Analyst, American Fuel and Petrochemical Manufacturers
- David Mica, Executive Director, Florida Petroleum Council
- Keith Robson; Manager of Corporate Safety, Security, and Emergency Management; Marathon Petroleum Company
- Craig Fugate, Chief Emergency Management Officer, One Concern
- Doug Baker, V.P. Industry Relations, Food Marketing Institute
- Christine Curtis, Senior Vice-President for Sales and Account Management, C&S Wholesale
- Dan Summers, Director, Bureau of Emergency Services, Collier County, Florida
- Akhil Agrawal, President, American Medical Depot
- Nicolette Louissaint, Executive Director, Healthcare Ready
- Linda Rouse O'Neill, Vice President of Government Affairs, Health Industry Distributors Association
- Michael Wargo, Vice President of Enterprise Readiness and Emergency Operations, Hospital Corporation of America Healthcare
- Kelley Burk, Director, Office of Energy, Florida Department of Agriculture and Consumer Services
- Beverly Byerts, Private Sector Disaster Coordinator, Florida Department of Economic Opportunity
- Martin Senterfitt, Fire Rescue Deputy Chief of Emergency Management, Monroe County, Florida
- Philip Palin, Principal Investigator, Institute for Public Research, CNA
- David Kaufman, VP and Director, Safety and Security, CNA
- Justin Boutilier, Jarrod Goentzel, Massachusetts Institute of Technology Humanitarian Supply Chain Lab, Center for Transportation and Logistics

*STRENGTHENING POST-HURRICANE SUPPLY CHAIN RESILIENCE*

**MEETING 5: ST. THOMAS, U.S. VIRGIN ISLANDS; MARCH 28, 2019**

- Nick Peake, Emergency Management Specialist, FEMA National Integration Center
- John Rigione, Deputy Logistics Chief, FEMA Region 2 (New York, New Jersey, Puerto Rico, U.S. Virgin Islands)
- Jonathan Garrett, FEMA in St. John
- Stevie Henri, Geographic Information Systems Analyst, University of the Virgin Islands
- Celia Victor, Administrator of Residential Services, Department of Human Services, U.S. Virgin Islands
- Regina Browne, Virgin Islands Territorial Emergency Management Agency
- Glenn Metts, Professor of Management and Entrepreneurship, University of the Virgin Islands
- Kim Waddell, Director of the Virgin Islands Experimental Program to Stimulate Competitive Research, University of the Virgin Islands
- Ernest Halliday, Chief Financial Officer, U.S. Virgin Islands Economic Development Authority
- Deanna James, Executive Director of St. Croix Foundation
- David L. Alderson, Associate Professor, Operations Research, Director, Center for Infrastructure Defense, Naval Postgraduate School
- Greg Guannel, Director of Caribbean Green Technology, University of the Virgin Islands

**WEBINAR: APRIL 28, 2019**

- Laura Kwinn Wolf, Director, Division of Critical Infrastructure Protection, Department of Health and Human Services Office of the Assistant Secretary for Preparedness and Response

## Appendix B

### Overview of the CNA Analyses

The information gathering and analyses carried out by the CNA investigators is presented in the following references, also shared directly online at <https://www.cna.org/research/hurricane-supply-chain>.

- Palin, P. J. 2018. Learning from H.I.M. (Harvey, Irma, Maria): Preliminary impressions for supply chain resilience. *Homeland Security Affairs* 14, Article 7. <https://www.hsaj.org/articles/14598> (accessed November 21, 2019)
- Palin, P. J., L. S. Hanson, D. Barton, and A. Frohwein. 2018. *Supply Chains and the 2017 Hurricane Season: A collection of case studies about Hurricanes Harvey, Irma, and Maria and their impact on supply chain resilience*. Arlington, VA: CNA Analysis and Solutions

This work includes a detailed time line of the three hurricanes and their impacts in each of the main study areas, and a helpful overview of the basic supply chain dynamics for motor fuels, public water supply, and retail food (see Figure B.1). Based on investigations and on-site field research in Texas (Houston and the Coastal Bend), Florida (Jacksonville, Orlando, and South Florida), Puerto Rico (San Juan, Comerio, and Yabucoa), and the U.S. Virgin Islands (Saint Croix), the CNA team then presents a series of case studies about key supply chains of interest (summarized in Table B.1). These include:

- Case study 1, “Retail Resilience in Puerto Rico,” which examines the surprising resilience of the retail sector supplying food and fuel after Hurricane Maria.
- Case study 2, “Static on the Relief Channel,” which investigates how food deliveries from the federal government created both real and perceived impacts on the retail food sector in Puerto Rico and caused spillover effects into other supply chains.
- Case study 3, “Resupplying Metro Miami,” which examines Florida during Hurricane Irma, specifically, how fuel availability affected the transportation of food and other goods before, during, and after the hurricane.



STRENGTHENING POST-HURRICANE SUPPLY CHAIN RESILIENCE

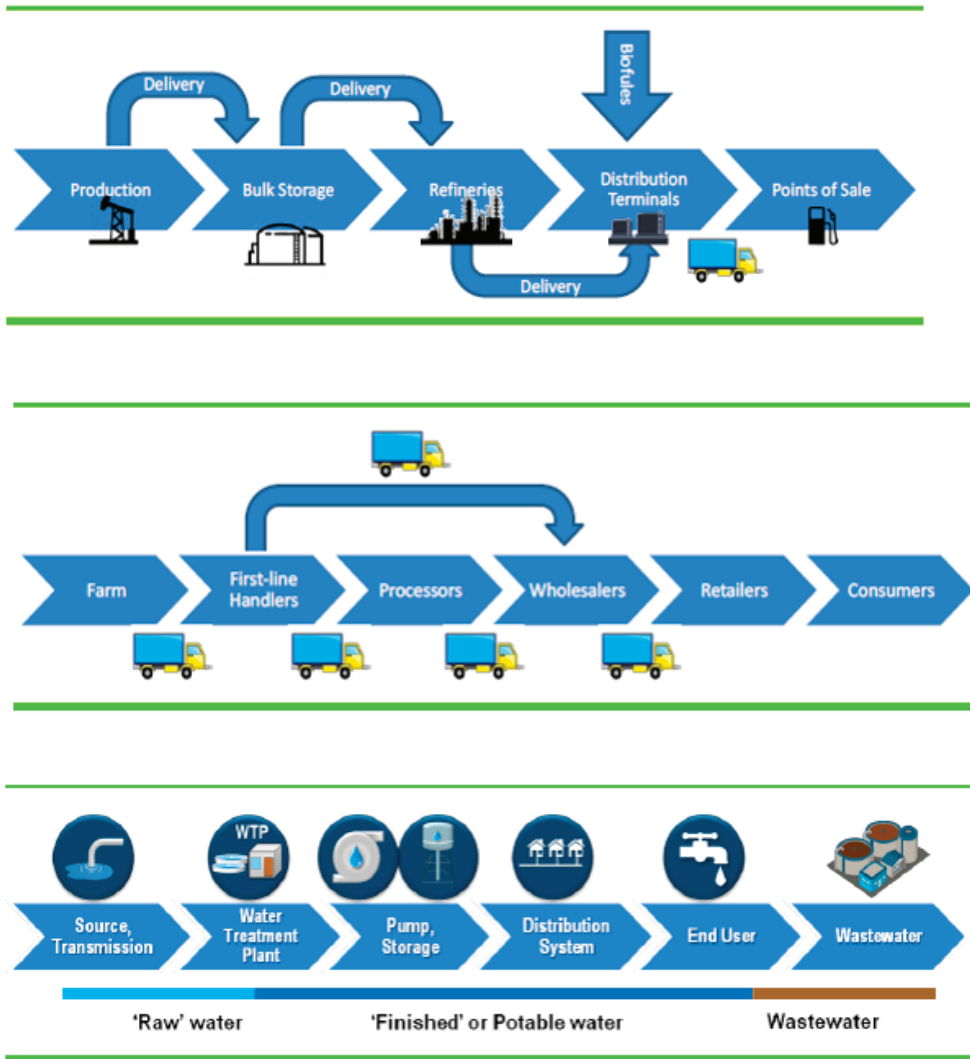

**FIGURE B.1** Generalized supply chains schematics for motor fuels (top), food products (middle), and public water systems (bottom).

SOURCE: Palin et al., 2018.

**TABLE B.1** CNA Case Studies' Subjects, Hurricanes Involved, Affected Areas, and Supply Chains of Concern

| Case Study Subject                  | Storm       | Area         | Supply Chains |
|-------------------------------------|-------------|--------------|---------------|
| Retail resilience                   | Maria       | Puerto Rico  | Food, fuel    |
| Static on the relief channel        | Maria       | Puerto Rico  | Food          |
| Resupplying metro Miami             | Irma        | Florida      | Fuel, food    |
| Water networks after Harvey         | Harvey      | Texas        | Water         |
| Box: Irma and the Florida Keys      | Irma        | Florida Keys | Water         |
| Constraints in optimized networks   |             |              |               |
| Retail cross-dock                   | Irma        | Florida      | Food          |
| Fuel networks                       | Irma        | Florida      | Fuel          |
| Ports                               | Irma, Maria | Puerto Rico  | General       |
| Manufacturing of intravenous fluids | Irma, Maria | Puerto Rico  | Medical       |

- Case study 4, “Harvey Turns On (and Then Turns Off) the Tap,” which looks at how Hurricane Harvey affected water suppliers, and what hindered and helped their ability to recover.
- Case study 5, “Constraints in Optimized Networks,” which looks at bottlenecks in supply chains in a variety of forms, using four examples from Florida and Puerto Rico.

An additional Case study 6, “External Factors—Debris and Donations,” is online only (not in the full report) and examines how specific local factors (post-storm debris management, unrequested donations) can influence the resilience of lifeline supply chains by changing the response environment and imposing burdens on local resources needed for disaster response.



## Appendix C

# Resources and Tools to Support Information Sharing

The Department of Homeland Security (DHS) has established several operations and tools to support information sharing within and among the critical infrastructure sectors.<sup>1</sup> These include

- Homeland Security Information Network - Critical Infrastructure (HSIN-CI).<sup>2</sup> The Homeland Security Information Network is the trusted network for homeland security mission operations to share sensitive but unclassified information. The critical infrastructure community on the network, HSIN-CI, is the primary system through which private sector owners and operators; DHS; and other federal, state, and local government agencies collaborate to protect the nation's critical infrastructure. HSIN-CI provides real-time collaboration tools including a virtual meeting space, document sharing, alerts, and instant messaging at no charge.
- Infrastructure Protection Gateway (IP Gateway).<sup>3</sup> The IP Gateway serves as the single interface through which DHS partners can access a large range of integrated infrastructure protection tools and information to conduct comprehensive vulnerability assessments and risk analysis.
- National Infrastructure Coordinating Center (NICC).<sup>4</sup> The NICC is the 24/7 information coordination and sharing operations center that maintains situational and operational awareness, communication, and coordination among the critical infrastructure public and private stakeholders.

---

<sup>1</sup> See <https://www.dhs.gov/emergency-services-sector-information-sharing-initiative>.

<sup>2</sup> See <https://www.dhs.gov/hsin-critical-infrastructure>.

<sup>3</sup> See <https://www.dhs.gov/cisa/ip-gateway>.

<sup>4</sup> See <https://www.dhs.gov/cisa/national-infrastructure-coordinating-center>.

## STRENGTHENING POST-HURRICANE SUPPLY CHAIN RESILIENCE

- National Risk Management Center (NRMC).<sup>5</sup> NRMC evaluates the potential consequences of disruptions across the cyber-physical domain through an integrated analytical approach that implements deliverables required by Presidential Policy Directive 21 and Executive Order 13636.
- Protected Critical Infrastructure Information (PCII) Program.<sup>6</sup> The PCII Program works with government organizations and the private sector to protect critical infrastructure information needed for effective incident management, as well as steady-state operations and preparedness.
- Protective Security Advisors (PSAs).<sup>7</sup> PSAs are security subject matter experts strategically deployed across the United States to protect the nation's critical infrastructure by providing state, local, tribal, territorial, and private sector partners access to DHS risk-mitigation tools, products, and services and by supporting officials responsible for planning and leading responses to major events. In addition, PSAs support response and recovery efforts to hazardous incidents through field-level coordination and information sharing.
- TRIP<sup>wire</sup> (Technical Resource for Incident Prevention).<sup>8</sup> TRIP<sup>wire</sup> is a 24/7, online, collaborative information-sharing and resource portal for bomb technicians, first responders, military personnel, government officials, intelligence analysts, private sector security professionals, and critical infrastructure owners and operators. TRIP<sup>wire</sup> is designed to increase awareness of evolving improvised explosive device (IED) tactics, techniques, and procedures, as well as share information about incident lessons learned and other counter-IED information.

DHS partners with other organizations and platforms to provide additional information-sharing support to its security partners. These include:

- Sector-specific agencies (SSAs).<sup>9</sup> SSAs maintain ongoing relationships with each critical infrastructure sector and often provide information essential to identify vulnerabilities and all-hazard risks and develop protective programs.
- Information Sharing Environment.<sup>10</sup> The federal Information Sharing Environment, managed by the Office of the Director of National Intelligence, facilitates information-sharing policies, procedures, and technologies.

<sup>5</sup> See <https://www.cisa.gov/national-risk-management>.

<sup>6</sup> See <https://www.dhs.gov/cisa/pcii-program>.

<sup>7</sup> See <https://www.dhs.gov/cisa/protective-security-advisors>.

<sup>8</sup> See <https://www.dhs.gov/tripwire>.

<sup>9</sup> See <https://www.dhs.gov/cisa/infrastructure-security-division>.

<sup>10</sup> See <https://www.dni.gov/index.php/nctc-who-we-are/organization/201-about/organization/information-sharing-environment>.

- Fusion centers.<sup>11</sup> Numerous states and large cities have established fusion centers to share information and intelligence.

DHS also partners with the Regional Consortium of Coordinating Councils, of which the following organizations are members:<sup>12</sup>

- Alaska Partnership for Infrastructure Protection
- All Hazards Consortium
- American Logistics Aid Network
- Association of Contingency Planners
- Bay Area Center for Regional Disaster Resilience
- Business Emergency Operations Center
- California Resiliency Alliance
- ChicagoFIRST, LLC
- Colorado Emergency Preparedness Partnership, Inc.
- Cyber Resilience Institute Organization
- Cyber Threat Intelligence Network Organization
- Financial Services Information Sharing and Analysis Center (FS-ISAC), Business Resiliency Committee
- Great Lakes Hazards Coalition
- InfraGard Los Angeles Members Alliance
- InfraGard Minnesota Members Alliance
- InfraGard Pittsburgh Members Alliance
- The Infrastructure Security Partnership
- Missouri Public Private Partnership
- The MITRE Corporation Organization
- National Health Information Sharing and Analysis Center
- Northeast Disaster Recovery Information X-Change
- Pacific Northwest Economic Region
- Pittsburgh Regional Business Coalition for Homeland Security
- Ready San Diego Business Alliance
- RPCfirst
- Safeguard Iowa Partnership
- Silver Shield - Critical Infrastructure Protection Program
- SoCalfirst
- South Florida Disaster Resiliency Coalition

<sup>11</sup> See <https://www.dhs.gov/fusion-centers>.

<sup>12</sup> See <https://rtriplec.wordpress.com/members/>.

*STRENGTHENING POST-HURRICANE SUPPLY CHAIN RESILIENCE*

- Southeast Emergency Response Network
- Southeast Wisconsin Homeland Security Partnership, Inc.
- U.S. Chamber of Commerce
- Utah Public Private Partnership Organization

## Appendix D

# Regulatory Assistance and Relevant Authorities for Disaster Relief by Federal Agencies

**D**uring catastrophic events, regulatory assistance or waivers are often used to expedite restoration efforts and support supply systems. Temporarily waiving the enforcement of certain safety, environmental, and statutory requirements, when appropriate, can accelerate response and recovery efforts for supply chains that support lifeline sectors. In the federal government, a number of departments and agencies are responsible for statutory and regulatory requirements that deal with fuels, water, food, health, and transportation. The following is an overview of some key provisions that each of these federal entities can enact that are of relevance to the functioning of supply chains during hazardous event. Also provided are some illustrations of how these various provisions were applied in the 2017 hurricane season.

### DEPARTMENT OF ENERGY

The Department of Energy (DOE) serves as the lead federal coordinating agency for Emergency Support Function (ESF) 12 – Energy under the National Response Framework.<sup>1</sup> DOE also has its own authorities under the Federal Power Act to address electricity shortages and secure the grid.<sup>2</sup> In addition, DOE can release crude oil from the strategic petroleum reserve.

- Federal Power Act, Section 202(c)  
The Secretary of Energy has authority in time of emergencies to order temporary interconnections of facilities and generation, delivery, interchange, or transmission

<sup>1</sup> See <https://www.energy.gov/oe/downloads/emergency-support-function-12-energy-annex>.

<sup>2</sup> Department of Energy, DOE Energy Waiver Library.



## STRENGTHENING POST-HURRICANE SUPPLY CHAIN RESILIENCE

of electricity that he or she deems necessary to meet needs in an emergency. The Secretary has used this authority in response to requests from the subsector, so the implementing regulations beginning at 10 CFR 205.370 describe an application process.

*In 2017:* The Federal Power Act was not invoked during the 2017 Hurricane season; however, it was used during Hurricane Ike in 2008 and Hurricane Katrina in 2005. Specifics can be found on the DOE Office of Electricity website.<sup>3</sup>

- Strategic Petroleum Reserve

DOE has oversight of the United States' strategic petroleum reserve, the largest government-owned stockpile of emergency crude oil in the world. Established in the aftermath of the 1973-74 oil embargo, the strategic petroleum reserve provides the President with a powerful response option should a disruption in commercial oil supplies threaten the U.S. economy. It is also the critical component for the United States to meet its International Energy Agency obligation to maintain emergency oil stocks. The strategic petroleum reserve has a storage capacity of 713.5 million barrels and as of February 22, 2019, has a current storage level of 649.1 million barrels.

Crude oil can be made available from the strategic petroleum reserve either as a drawdown and sale based on a finding of a severe energy supply disruption or as a time exchange whereby the recipient receives crude from the reserve in exchange for a delivery of crude oil at an agreed future time.

*In 2017:* In August 2017, as a result of Hurricane Harvey, many ports, Gulf Coast refineries, and Gulf of Mexico oil-production facilities were shut down. As a result, the DOE exchanged 5.2 million barrels of crude oil from the Strategic Petroleum Reserve that was made available to refineries via pipeline delivery. The crude oil helped refineries to continue operations and prevent further supply disruptions.<sup>4</sup>

## ENVIRONMENTAL PROTECTION AGENCY

The Environmental Protection Agency (EPA) and most states have requirements on gasoline and diesel fuel specifications that are designed to limit emissions. Waiving certain fuel specifications may increase overall fuel supplies and may allow supplies of gasoline to be delivered and used in areas where the product may not normally be used. EPA, in coordination with DOE, may consider waiving sections of the Clean Air Act 211(c)(4)(c) to facilitate fuel supply in the event of an unforeseen emergency supply disruption. Waiving certain fuel standards can ensure that supplies of fuel are available, especially for emergency operations

<sup>3</sup> See <https://www.energy.gov/oe/does-use-federal-power-act-emergency-authority>.

<sup>4</sup> See <https://www.energy.gov/fe/services/petroleum-reserves/strategic-petroleum-reserve/spr-quick-facts-and-faqs>.

and the lifeline sectors. EPA regulates Reid vapor pressure (RVP)—a measure of the volatility of gasoline during summer months only, and reformulated gasoline, a special gasoline required in certain areas of the country to reduce emissions and meet clean air requirements. Unlike RVP, reformulated gasoline programs are in effect year-round.

In addition to DOE, EPA typically consults with states affected by a fuel supply situation to determine the scope, duration, and details of a fuel waiver. A formal request for an EPA fuel waiver is normally made by, or on behalf of, the governor of the impacted state. Private sector companies may also request waivers if conditions warrant such a request.

- Reformulated gasoline requirements: Reformulated gasoline is a blended gasoline, a cleaner-burning alternative to conventional gasoline that is required to meet a threshold of air quality metrics in 17 states and the District of Columbia.<sup>5</sup> During emergency response situations, it is important to ensure that adequate supplies of gasoline fuel are available.
- Gasoline Reid vapor pressure: EPA regulates the vapor pressure of gasoline sold at retail stations during the summer ozone season to reduce evaporative emissions from gasoline that contribute to ground-level ozone to diminish the effects of ozone-related health problems. Depending upon the state and month, gasoline may not exceed 7.8 pounds per square inch RVP or 9.0 pounds per square inch RVP. An overview and list of RVP requirements may be viewed on the EPA website.<sup>6</sup> *In 2017:* During the 2017 hurricane season, EPA issued a number of waivers related to fuel supply.<sup>7</sup> Highlights of EPA response activities during the 2017 hurricane season can be found on the EPA website.<sup>8</sup>

## DEPARTMENT OF TRANSPORTATION

Under the National Response Framework, the Department of Transportation is the primary federal agency for Emergency Support Function (ESF) – 1, Transportation.<sup>9</sup> During emergency situations, the department posts information related to transportation permits, waivers, and other regulations and authorities. An overview of all Department of Transportation agencies and fact sheets can be found at the Emergency Preparedness, Response, and Recovery Information website.<sup>10</sup> The following agencies have purview over various safety regulations that may be considered for exemption during emergencies.

<sup>5</sup> See <https://www.epa.gov/gasoline-standards/reformulated-gasoline>.

<sup>6</sup> See <https://www.epa.gov/gasoline-standards/gasoline-reid-vapor-pressure>.

<sup>7</sup> See <https://www.epa.gov/enforcement/fuel-waivers#2017>.

<sup>8</sup> See [https://www.epa.gov/sites/production/files/2018-03/documents/year\\_in\\_review\\_3.5.18.pdf](https://www.epa.gov/sites/production/files/2018-03/documents/year_in_review_3.5.18.pdf).

<sup>9</sup> See <http://www.fema.gov/pdf/emergency/nrf/nrf-annexes-all.pdf>.

<sup>10</sup> See <https://www.transportation.gov/emergency>.

## STRENGTHENING POST-HURRICANE SUPPLY CHAIN RESILIENCE

**FEDERAL MOTOR CARRIER SAFETY ADMINISTRATION**

Emergency treatment under the Federal Motor Carrier Safety Regulations is automatically triggered under a declared emergency (as defined in the regulations). A declaration of emergency under the Federal Motor Carrier Safety Regulations, which can be declared by the President of the United States, the governor of the impacted state, or the Federal Motor Carrier Safety Administration field administrator for the geographical area in which the emergency has occurred, initiates complete exemption from all of the safety regulations contained under 49 CFR Parts 390–399. These include, but are not limited to, the following.

- Hours of service requirements  
The Federal Motor Carrier Safety Regulations regulate the number of hours that drivers of commercial motor vehicles may drive and the number of hours that a commercial motor vehicle driver may be on duty before rest is required, as well as the minimum amount of time that must be reserved for rest and the total number of hours a driver may be on duty in a work week.<sup>11</sup> During times of emergency, fuel shortages may exist or mutual assistance crews may be traveling from distant locations to aid in efforts to restore electricity. The waiving of hours of service requirements allows drivers to transport goods such as fuel over longer distances to help alleviate any shortages and allows electric utility crews to arrive sooner. Hours of service requirements are normally waived during disasters but may also be issued during fuel shortages caused by other events, such as an unanticipated shutdown of a refinery, a disruption to a pipeline, or a widespread power outage. Motor carriers are exempt from hours of service requirements throughout their route as long as their destination state is under a state of emergency. No additional action is required beyond the issuance of the emergency or disaster declaration in order for these measures to be placed in effect; however, a state declaration can specify the commodities covered, such as heating fuels or gasoline and diesel fuel. The Federal Motor Carrier Safety Regulations emergency webpage contains active and archived information regarding emergency declarations, waivers, exemptions, and permits, including the list of hours of service waivers during 2017.<sup>12</sup>

**FEDERAL HIGHWAY ADMINISTRATION**

- Oversize and overweight permits  
Section 127 of title 23, U.S.C. establishes weight limitations for vehicles operating on the federal interstate highway system. Those maximum weight limitations are

<sup>11</sup> See <https://www.fmcsa.dot.gov/regulations/hours-service/summary-hours-service-regulations>.

<sup>12</sup> See <https://www.fmcsa.dot.gov/emergency>.

as follows: single axle, 20,000 pounds; tandem axle, 34,000 pounds; and gross weight, 80,000 pounds (or the maximum allowed by the federal bridge formula). Section 127 states that the overall gross weight may not exceed 80,000 pounds, including all enforcement tolerances, except for those vehicles and loads that cannot be easily dismantled or divided and that have been issued special permits in accordance with applicable state laws. This language establishes the states' authority to issue special permits to "non-divisible" loads. Examples of non-divisible loads include bulldozers, large generators, scrapers, and modular homes.

Oversize and overweight permits are issued exclusively to vehicles and loads that are delivering relief supplies. The maximum gross weight limit that states must enforce on the interstate highway system is 80,000 pounds, unless a lower weight is derived from the bridge formula or a higher weight is grandfathered. However, governors of states under emergency declaration may have the authority to waive weight limits for petroleum tanker trucks. Such measures would only apply on a state by-state basis, and, should trucks have to go out of state for fuel supplies, they would be subject to weight limits in the states through which they would need to pass.

Section 1511 of MAP-21 extends the states' authority to issue special permits to vehicles with divisible loads that are delivering relief supplies during a presidentially declared emergency or major disaster under the Robert T. Stafford Disaster Relief and Emergency Assistance Act (Stafford Act) (42 U.S.C. 5121 et seq.).<sup>13</sup>

*In 2017:* During the 2017 hurricane season select states including Texas, Louisiana, and Florida issued special permits for relief efforts.

## PIPELINE AND HAZARDOUS MATERIALS SAFETY ADMINISTRATION

- Special Hazardous Material Permits

During an incident, the Pipeline and Hazardous Materials Safety Administration has the ability to issue an emergency special permit without notice and comment or hearing if the associate administrator of pipeline safety determines that such action is in the public interest, is not inconsistent with pipeline safety, and is necessary to address an actual or impending emergency involving pipeline transportation. Special permits are authorized by statute in 49 U.S.C. § 60118(c),<sup>14</sup> and the application process is set forth in 49 CFR 190.341.<sup>15</sup> Once a request for an emergency special permit is received, the Pipeline and Hazardous Materials Safety Administration will determine

<sup>13</sup> See [https://ops.fhwa.dot.gov/freight/policy/rpt\\_congress/truck\\_sw\\_laws/index.htm#exempt](https://ops.fhwa.dot.gov/freight/policy/rpt_congress/truck_sw_laws/index.htm#exempt).

<sup>14</sup> See [http://frwebgate.access.gpo.gov/cgi-bin/usc.cgi?ACTION=RETRIEVE&FILE=\\$\\$xa\\$\\$busc49.wais&start=8631437&SIZE=11122&TYPE=TEXT](http://frwebgate.access.gpo.gov/cgi-bin/usc.cgi?ACTION=RETRIEVE&FILE=$$xa$$busc49.wais&start=8631437&SIZE=11122&TYPE=TEXT).

<sup>15</sup> See [https://www.ecfr.gov/cgi-bin/text-idx?SID=07875a682986afba8f2df312c5c20c62&mc=true&node=se49.3.190\\_1341&rgn=div8](https://www.ecfr.gov/cgi-bin/text-idx?SID=07875a682986afba8f2df312c5c20c62&mc=true&node=se49.3.190_1341&rgn=div8).

## STRENGTHENING POST-HURRICANE SUPPLY CHAIN RESILIENCE

on a case-by-case basis what duration is necessary to address the emergency. However, as required by statute, no emergency special permit may be issued for a period of more than 60 days, and each permit will automatically expire on the date specified in the permit. Emergency special permits may be renewed upon application to the Pipeline and Hazardous Materials Safety Administration only after notice and opportunity for a hearing on the renewal.

*In 2017:* A number of special permits were issued during the 2017 hurricane season, with noted benefits.<sup>16</sup> According to the American Fuel and Petrochemical Manufacturers, “the waivers supported the movement of essential fuels and recovery products to impacted areas that aided in the recovery. In addition, following the event to ensure safe operation of pipeline infrastructure, pipeline operators must conduct inspections and in some cases repair to damaged infrastructure. To assist in these efforts the Pipeline and Hazardous Materials Safety Administration issued an emergency stay of enforcement for operators affected by hurricanes. This stay provided companies with a larger pool of skilled workers to aid in recovery. This relief aided in the recovery efforts and ensured essential mid-stream energy infrastructure resume operation quickly.”<sup>17</sup>

**DEPARTMENT OF HOMELAND SECURITY**

- Jones Act  
The Merchant Marine Act, also known as the Jones Act, prohibits any foreign-built, foreign-owned, or foreign-flag vessel (foreign vessels) from transporting goods between U.S. ports. The same prohibitions apply to U.S.-flag vessels that are not coastwise-qualified. However, during emergency responses, resources, including shipping vessels, can be scarce. The Jones Act can be waived, but only in the interest of national defense. When the Jones Act is waived, foreign vessels and U.S.-flag vessels that are not coastwise-qualified are authorized to transport goods between U.S. ports. If the secretary of defense requests a Jones Act waiver, the secretary of DHS must grant a Jones Act waiver to the extent that he or she considers necessary in the interest of national defense. For all other Jones Act waiver requests, the secretary of DHS may grant a Jones Act waiver if (i) the he or she considers it necessary in the interest of national defense, and (ii) the administrator of the Maritime Administration, a component of the Department of Transportation, has determined that no qualified

<sup>16</sup> See <https://www.phmsa.dot.gov/pipeline/special-permits-state-waivers/rail-road-commission-texas-8302017-0>, <https://www.phmsa.dot.gov/regulations-fr/notices/2017-20356>, and <https://www.phmsa.dot.gov/regulations-fr/notices/2017-20355>.

<sup>17</sup> See [https://www.afpm.org/uploadedFiles/Content/Policy\\_Positions/Congressional\\_Testimony/20171031-AFPM-testimony.pdf](https://www.afpm.org/uploadedFiles/Content/Policy_Positions/Congressional_Testimony/20171031-AFPM-testimony.pdf).

U.S.-flag vessels are available to meet the national defense requirements. Additional information on coastwise trade, including waiver information, can be found in the Customs and Border Protection's informed compliance publication, available online.<sup>18</sup> To request a Jones Act waiver, a request must be made to DHS Customs and Border Protection. A Jones Act waiver request is coordinated with the heads of other relevant agencies, which, depending on the nature of the request, include the Maritime Administration, the Coast Guard, the Department of Defense, and the Department of Energy. The Department of Energy monitors energy supply needs and advises Customs and Border Protection during periods of actual or imminent shortages of energy on requests for waivers of the Jones Act.

Based on consultation and concurrence by the Department of Energy (to the extent that it involves energy supply), the Department of Defense, and the Maritime Administration, the secretary of DHS may issue a Jones Act waiver permitting foreign vessels and U.S.-flag vessels that are not coastwise-qualified to transport petroleum products including various feedstocks, blending components, and additives used to produce fuels to the impacted areas.

*In 2017:* The Jones Act was waived three times during the 2017 hurricane season. A list of Jones Act waivers can be found on the DHS website.<sup>19</sup>

## FEDERAL ENERGY REGULATORY COMMISSION

An area of Federal Energy Regulatory Commission (FERC) oversight is the regulation of rates and practices of oil pipeline companies engaged in interstate transportation. The commission establishes equal service conditions to provide shippers with equal access to pipeline transportation and sets reasonable rates for transporting petroleum and petroleum products by pipeline. FERC can act on requests to waive pipeline tariff provisions during an emergency. As such, it has the ability to prioritize shipments of propane and other liquid fuels through pipelines in the event of emergencies and supply shortages.<sup>20</sup>

*In 2017:* During Hurricane Harvey, the FERC approved an emergency waiver tariff to allow the Colonial Pipeline system to accept 11.5 RVP gasoline (A3) to fill nominations for 7.8 RVP gasoline (A1) and 9.0 RVP gasoline (A2) (see descriptions of gasoline formulations above), and to ship conventional gasoline in lieu of reformulated gasoline. This pipeline system's tariffs and tariff practices would not normally permit it to accept product that does not conform to the specifications of the product that was nominated.<sup>21</sup>

---

<sup>18</sup> See <https://www.cbp.gov/trade/jones-act-waiver-request>.

<sup>19</sup> See <https://www.dhs.gov/publication/september-2017-jones-act-waivers>.

<sup>20</sup> See <https://www.ferc.gov/industries/oil.asp>.

<sup>21</sup> See <https://www.ferc.gov/CalendarFiles/20170905171027-OR17-23-000.pdf>.

## STRENGTHENING POST-HURRICANE SUPPLY CHAIN RESILIENCE

**INTERNAL REVENUE SERVICE**

Special tax assistance may be available to taxpayers in presidentially declared disaster areas as part of the coordinated federal response to disasters based on local damage assessments by FEMA.

- *Dyed Diesel Fuel Waivers.* There are typically two types of diesel sold in the United States: dyed diesel fuel (that is literally red), used only in off-road vehicles or for non-highway use, such as farm tractors, heavy construction equipment, home heating, and generators; and non-dyed diesel fuel for use in on-road vehicles. The Internal Revenue Service imposes a highway excise tax of 24.4 cents per gallon on diesel fuel sold for on-road use, whereas dyed diesel fuel is not ordinarily subject to this tax. Under normal circumstances, on-road vehicles found to have red diesel fuel in their fuel tanks may face enforcement action.<sup>22</sup> During emergencies the Internal Revenue Service may temporarily waive the tax penalty for dyed diesel fuel being sold for use on the road, in an effort to free up additional supplies of diesel fuel. *In 2017:* In response to shortages of undyed diesel fuel caused by Hurricane Harvey and Irma, the Internal Revenue Service waived the penalty when dyed diesel fuel is sold for use or used on the highway. A list of waivers can be found on the Internal Revenue Service website.<sup>23</sup>

**DEPARTMENT OF HEALTH AND HUMAN SERVICES**

When the President declares a disaster or emergency under the Stafford Act or National Emergencies Act, the secretary of health and human services may declare a public health emergency under Section 319 of the Public Health Service Act, authorizing the secretary to take certain actions in addition to his or her regular authorities.

- **Section 1135 of the Social Security Act**  
Per Section 1135 of the Social Security Act, the secretary may temporarily waive or modify certain Medicare, Medicaid, and Children's Health Insurance Program requirements to ensure (i) that sufficient health care items and services are available to meet the needs of individuals enrolled in Social Security Act programs in the emergency area and time periods, and (ii) that providers who provide such services in good faith can be reimbursed and exempted from sanctions (absent any determination of fraud or abuse).<sup>24</sup>

<sup>22</sup> See <https://www.irs.gov/pub/irs-pdf/p4941.pdf>.

<sup>23</sup> See [https://www.irs.gov/site-index-search?search=diesel+fuel+penalty+during+irma&field\\_pup\\_historical\\_1=1&field\\_pup\\_historical=1](https://www.irs.gov/site-index-search?search=diesel+fuel+penalty+during+irma&field_pup_historical_1=1&field_pup_historical=1).

<sup>24</sup> See <https://www.cms.gov/Medicare/Provider-Enrollment-and-Certification/SurveyCertEmergPrep/Downloads/Extraordinary-Circumstances-Exception-Hurricane-Harvey.pdf>.



*In 2017:* A list of actions taken by the Department of Health and Human Services during the 2017 hurricane season can be found on its website.<sup>25</sup>

- Public Health Emergencies (PHE), Paperwork Reduction Act Waivers

*In 2017/18:* Pursuant to section 319 of the Public Health Services Act, Secretary Azar determined that, as the result of the consequences of Hurricane Maria, a public health emergency had existed in the U.S. Virgin Islands beginning on March 15, 2018, and in Puerto Rico beginning on March 16, 2018. The secretary's decision to declare the public health emergency was made after consultation with public health officials as necessary. As result of the public health emergency, the secretary also determined, pursuant to section 319(f) of the Public Health Services Act, that circumstances of the public health emergency necessitated a waiver from the requirements of the Paperwork Reduction Act, 44 U.S.C. § 3501 et seq., effective May 21, 2018. The waiver was justified to facilitate the collection of information to support the Department of Health and Human Services' investigation of and response to Hurricane Maria and was in effect until October 19, 2018.<sup>26</sup>

## **U.S. DEPARTMENT OF AGRICULTURE**

As part of the National Response Framework, the U.S. Department of Agriculture's Food and Nutrition Service provides assistance to those most affected by a disaster or emergency. It coordinates with state, local, and voluntary organizations to provide food for shelters and other mass feeding sites, distribute food packages directly to households in need in limited situations, and approve operation of the Disaster Supplemental Nutrition Assistance Program.

*In 2017:* During the 2017 hurricane season, the Food and Nutrition Service approved food disaster relief assistance in Texas (select counties), Florida, and Puerto Rico.<sup>27</sup>

## **NATIONAL POLICY DIRECTIVES AND FRAMEWORKS TO SUPPORT THE PRIVATE SECTOR**

### **Robert T. Stafford Disaster Relief and Emergency Assistance Act – Presidential Declaration**

According to the Robert T. Stafford Disaster Relief and Emergency Assistance Act, FEMA can consider private sector requests for assistance. A private sector owner or operator

<sup>25</sup> See <https://www.hhs.gov/about/agencies/asl/testimony/2017-10/examining-hhs-s-public-health-preparedness-and-response.html>.

<sup>26</sup> See <https://aspe.hhs.gov/public-health-emergency-declaration-pra-waiver>.

<sup>27</sup> See <https://www.fns.usda.gov/disaster/texas-disaster-nutrition-assistance>, <https://www.fns.usda.gov/disaster/usda-disaster-food-assistance-help-florida>, and <http://www.frac.org/blog/nutrition-programs-respond-recent-disasters-live-updates>.



## STRENGTHENING POST-HURRICANE SUPPLY CHAIN RESILIENCE

of a “critical infrastructure and key resource” may receive direct or indirect assistance from federal government sources when the need meets the following four criteria:

- Exceeds the capabilities of the private sector and relevant local, state, tribal, territorial, and insular area governments
- Relates to immediate threat to life and property
- Is critical to disaster response or community safety
- Relates to essential federal recovery measures

In certain circumstances, federal law requires appropriate authorities to include private sector representatives in incident management planning, operations, and exercises. Even when not required, it encourages such participation whenever practical. The federal government may direct private sector response resources in some cases in which contractual relationships exist.<sup>28</sup>

### Defense Production Act

The Defense Production Act is the primary source of presidential authority to expedite and expand the supply of critical resources from the U.S. industrial base to support the national defense and homeland security. In addition to military, energy, and space activities, the Defense Production Act’s definition of national defense includes emergency preparedness activities conducted pursuant to Title VI of the Stafford Act; protection and restoration of critical infrastructure; and efforts to prevent, reduce vulnerability to, minimize damage from, and recover from acts of terrorism within the United States. The President’s authorities under the act are delegated to the head of various federal departments in Executive Order 13603. Defense Production Act cannot necessarily increase the production of critical resources if those production lines are already operating at a maximum capacity, and thus may not prevent shortages if the demand for such resources are high.

While primarily for federal procurement, the Defense Production Act priorities and allocations authority can also directly assist a private sector critical infrastructure owner or operator when the request is necessary or appropriate to support national defense. The act broadly defines national defense to include emergency preparedness activities to:

- Prepare for or minimize the effects of a hazard upon the civilian population;
- Deal with the immediate emergency conditions that the hazard creates; and
- Effectuate emergency repairs to, or the emergency restoration of, vital utilities and facilities that the hazard destroyed or damaged.

---

<sup>28</sup> See <https://www.fema.gov/robert-t-stafford-disaster-relief-and-emergency-assistance-act-public-law-93-288-amended> and <https://www.fema.gov/media-library/assets/documents/175527>.

The use of this authority does not require a declaration of emergency. The process starts with a request from a private sector entity for a priority rating. Under normal circumstances Defense Production Act requests can go to different organizations in various ways; however, during presidentially declared disasters they should go to the federal coordinating officer at the Joint Field Office. The federal coordinating officer then determines whether to support the request and initiates coordination accordingly.

## NATIONAL PLANNING FRAMEWORKS

FEMA Preparedness includes prevention, protection, mitigation, response, and recovery.<sup>29</sup> The National Planning Frameworks, one for each preparedness mission area, describe how the whole community works together to achieve the National Preparedness Goal.<sup>30</sup> The goal, the cornerstone for the implementation of the National Preparedness System, is “a secure and resilient nation with the capabilities required across the whole community to prevent, protect against, mitigate, respond to, and recover from the threats and hazards that pose the greatest risk.” The Goal is the cornerstone for the implementation of the National Preparedness System.<sup>31</sup>

The National Planning Frameworks are part of the National Preparedness System. There is one Framework for each of the five preparedness mission areas:<sup>32</sup>

- National Prevention Framework
- National Protection Framework
- National Mitigation Framework
- National Response Framework
- National Disaster Recovery Framework

---

<sup>29</sup> See <https://www.fema.gov/national-planning-frameworks>.

<sup>30</sup> See <https://www.fema.gov/whole-community>, <https://www.fema.gov/national-preparedness-goal>, and [https://www.fema.gov/media-library-data/1443703117389-27c542ca395218d3154e5c1dfa8bfc6/National\\_Preparedness\\_Goal\\_Whats\\_New\\_2015.pdf](https://www.fema.gov/media-library-data/1443703117389-27c542ca395218d3154e5c1dfa8bfc6/National_Preparedness_Goal_Whats_New_2015.pdf).

<sup>31</sup> See <https://www.fema.gov/national-preparedness-system>, and [https://www.fema.gov/media-library-data/20130726-1855-25045-8110/national\\_preparedness\\_system\\_final.pdf](https://www.fema.gov/media-library-data/20130726-1855-25045-8110/national_preparedness_system_final.pdf).

<sup>32</sup> See <https://www.fema.gov/media-library/assets/documents/117762>, <https://www.fema.gov/media-library/assets/documents/117782>, <https://www.fema.gov/media-library/assets/documents/117787>, <https://www.fema.gov/media-library/assets/documents/117791>, and <https://www.fema.gov/media-library/assets/documents/117794>.



# Appendix E

## Committee Biographies

**JAMES G. FEATHERSTONE** (CHAIR), M.S., became president and chief executive officer of the Los Angeles Homeland Security Advisory Council in March 2016 after serving the city of Los Angeles for 30 years. At the Los Angeles Homeland Security Advisory Council, Mr. Featherstone continues to strengthen the Greater Los Angeles region's crisis readiness and resilience by convening and connecting the private, public, and civic sectors through collaborative partnerships and strategic alliances, emerging technology, and research. A native of Washington, D.C., and a veteran of the United States Navy, he began his public service to the city of Los Angeles in 1986 with the Los Angeles Fire Department and was later appointed interim fire chief (2013-2014). In 2007, he was appointed general manager of the Los Angeles Emergency Management Department, where he led a successful departmental reorganization and restructured the city's emergency management protocols and processes. Mr. Featherstone holds a master's degree in leadership from the University of Southern California and is an alumnus of the Executive Leaders Program at the Naval Postgraduate School's Center for Homeland Defense and Security. He is a senior fellow in the Harvard University Kennedy School of Government's Program on Crisis Leadership.

**ÖZLEM ERGUN**, Ph.D., is a professor of mechanical and industrial engineering at Northeastern University. Dr. Ergun's research focuses on design and management of large-scale and decentralized networks. She has applied her work on network design, management, and resilience to problems arising in many critical systems including transportation, pharmaceuticals, and health care. Her passion is in identifying important problems in global health, emergency response, and humanitarian supply chains, and working with partner organizations to resolve these problems by using mathematical modeling and analytics while helping to build an analytical culture within the partner organizations. She has worked with organizations that respond to emergencies and humanitarian crises around the world, including the U.S. Agency for International Development, United Nations World Food Programme, United Nations High Commissioner for Refugees, International Federation of Red Cross and Red Crescent

## STRENGTHENING POST-HURRICANE SUPPLY CHAIN RESILIENCE

Societies, OXFAM America, CARE USA, Federal Emergency Management Agency, Army Corps of Engineers, Centers for Disease Control and Prevention, Atlanta-Fulton County Emergency Management Agency, and MedShare International. Dr. Ergun also regularly teaches courses on supply chain optimization to professionals from the health and humanitarian sector. Within the Institute for Operations Research and the Management Sciences (INFORMS), Dr. Ergun has been a leader in establishing a strong community of Operations Research professionals with an interest in public programs. She is a past president of the INFORMS section on public programs, service, and needs and currently serves as an editor at the *Operations Research Journal for Policy Modeling*. Dr. Ergun is a founding co-chair of the Health and Humanitarian Logistics Conference, held annually since 2009. Prior to joining Northeastern, Dr. Ergun was the Coca-Cola Associate Professor in the School of Industrial and Systems Engineering at Georgia Institute of Technology, where she co-founded and co-directed the Health and Humanitarian Systems Research Center at the Supply Chain and Logistics Institute. She received a Ph.D. in operations research from the Massachusetts Institute of Technology in 2001.

**KATHY FULTON**, M.S., M.B.A., is executive director for American Logistics Aid Network. She leads the organization in facilitating donations of logistics services and equipment to enable delivery of humanitarian aid. Ms. Fulton served as the organization's director of operations from 2010 until her promotion in 2014. In 2019, she was named as a DC Velocity "Rainmaker." Ms. Fulton's work focuses on the intersection of supply chains and emergency management, with specific attention to the critical role played by logistics and supply chain professionals in disaster relief. She is a member of national workgroups focused on efficient coordination of logistics activities during disasters, including the Department of Homeland Security Highway Motor Carrier Sector Coordinating Council; the Transportation Research Board Standing Committee on the Logistics of Disaster Response, Business Continuity and Humanitarian Response (ABR20); the National Voluntary Organizations Active in Disaster Donations Management Committee; and the National Emergency Management Association Private Sector Committee. Preceding her work with American Logistics Aid Network, Ms. Fulton was senior manager of information technology services at Saddle Creek Logistics Services, where she led information technology infrastructure implementation and support, corporate systems, and business continuity planning. Ms. Fulton holds a B.S. in mathematics from Northwestern State University of Louisiana and master's degrees in business administration (concentration in supply chain management) and management information systems from the University of South Florida.

**WALLACE (WALLY) HOPP**, Ph.D. (NAE), is the C.K. Prahalad Distinguished University Professor of Business and Engineering at the University of Michigan, Ross School of Business. Dr. Hopp's research focuses on the design, control, and management of operations systems, with

emphasis on manufacturing and supply chain systems, innovation processes, and health care systems. He has won numerous awards, including the 1990 Scaife Award for the paper with the “greatest potential for assisting an advance of manufacturing practice,” the 1998 Institute of Industrial Engineers Joint Publishers Book-of-the-Year Award for *Factory Physics*, the 2005 Institute of Industrial Engineers Technical Innovation Award and 2006 Society of Manufacturing Engineers Education Award, the 2010 Pierskalla Best Paper Award from the Institute for Operations Research and the Management Sciences (INFORMS) Health Care Applications Section, the 2011 Ross School of Business Senior Research Award, and best paper awards in 2016 from the *Manufacturing and Service Operations Management Journal* and the Manufacturing and Service Operations Management’s Service Management Special Interest Group. Dr. Hopp is a fellow of the Institute of Industrial and Systems Engineers, INFORMS, SME, the Manufacturing and Service Operations Management Society, and the Production and Operations Management Society, and is an elected member of the National Academy of Engineering. He served as president of the Production and Operations Management Society and editor-in-chief of the journal *Management Science*, and is currently a senior editor of *Production and Operations Management*. He is an active industry consultant whose clients have included Abbott Laboratories, Bell & Howell, Black & Decker, Boeing, Case, Dell, Ford, Eli Lilly, Eaton, Emerson Electric, General Electric, General Motors, John Deere, IBM, Intel, Motorola, Owens Corning, Schlumberger, S&C Electric, Texas Instruments, Whirlpool, Zenith, and others. Dr. Hopp received his B.S. in physics from Michigan State University, an M.S. in technology and human affairs from Washington University, and an M.S. and his Ph.D. in industrial and operations engineering from the University of Michigan.

**PINAR KESKINOCAK**, Ph.D., is the William W. George Chair and Professor in the Stewart School of Industrial Engineering, and co-founder and director of the Center for Health and Humanitarian Systems. She also serves as the College of Engineering ADVANCE (Organizational Change for Gender Equity in STEM Academic Professions) Professor. Previously, she worked at IBM T.J. Watson Research Center. She received her Ph.D. in operations research from Carnegie Mellon University and her M.S. and B.S. in industrial engineering from Bilkent University. Dr. Keskinocak’s research focuses on the applications of operations research and management science with societal impact, particularly health and humanitarian applications, supply chain management, and logistics and transportation. Her recent work has addressed infectious disease modeling, evaluating intervention strategies, and resource allocation; catch-up scheduling for vaccinations; hospital operations management; disaster preparedness and response (e.g., pre-positioning inventory); debris management; and centralized and decentralized price and lead time decisions. She has worked on projects with companies, governmental and nongovernmental organizations, and health care providers, including American Red Cross, CARE, Carter Center, Centers for Disease Control and Prevention, Children’s Healthcare of Atlanta, Emory University, and Intel Corporation. She

## STRENGTHENING POST-HURRICANE SUPPLY CHAIN RESILIENCE

has served as a department editor for *Operations Research* (policy modeling and public sector area), associate editor for *Manufacturing & Service Operations Management*, INFORMS secretary, and INFORMS vice president of membership and professional recognition. She was the co-founder and past-president of the INFORMS section on public programs, service, and needs, and the president of the INFORMS Health Applications Society.

**BRYAN KOON**, M.S., serves as vice president of Florida Homeland Security and Emergency Management at IEM, a global security consulting firm. He is the former director of the Florida Division of Emergency Management and serves as IEM's vice president of homeland security and emergency management. Mr. Koon has spent his career focused on improving emergency response operations and engaging communities in becoming better prepared for emergencies and disasters. Mr. Koon was appointed by Florida Governor Rick Scott in 2011 to be the state's director of emergency management. In this position, Mr. Koon managed the division's responsibilities in planning for, responding to, and recovering from natural and human-caused disasters. This included preparing and implementing the statewide Comprehensive Emergency Management Plan, conducting state and local exercises and training to improve preparedness capabilities, and acting as liaison between the Florida Division of Emergency Management and federal and state agencies. In addition to serving as IEM vice president, Mr. Koon serves as chair of the Multi-Hazard Mitigation Council. The council is composed of leading experts in mitigation and serves as an independent, nongovernmental, nonprofit entity that advocates for smart mitigation practices nationwide. Prior to working for Florida, Mr. Koon was the operations manager and director of emergency management for Wal-Mart. There, he was responsible for emergency management operations for 8,500 facilities and 2.2 million employees worldwide during disasters. Mr. Koon worked as a White House contractor with SRA International, building off his work as training officer for presidential contingency programs under the Navy. While on active duty with the Navy, Mr. Koon worked at the White House Military Office in the President's Emergency Operations Center. Mr. Koon was a commissioner of the Emergency Management Accreditation Program. He was also vice chairman of the Multi-Hazard Mitigation Council, sat on the board of directors of the National Information Sharing Consortium, and was president of the National Emergency Management Association. He has an M.B.A. and a graduate certificate in emergency and crisis management from George Washington University.

**ALICE LIPPERT**, M.S., is a senior expert on domestic energy markets, infrastructure, and energy-supply trends. At the Department of Energy, she served as a senior technical advisor and was a principal contact for a variety of complex energy issues and energy-emergency events requiring the review of interdependencies and market impacts. She has expertise in Department of Energy authorities and government programs related to the Clean Air Act, Jones Act, homeland security, and pipeline security and safety, including waiver processes



involving federal government energy programs. She often served as the liaison for special, high-visibility exercises, studies, and analyses involving senior representatives from the department, federal, state, and local governments, national laboratories, and the private sector. In 2014, she served on the Secretary of Energy's National Petroleum Council Study to examine the Department of Energy's emergency response program. She has extensive experience in responding to energy supply disruptions and emergency events. During major energy events, she has often served as the emergency response operations director. She was formerly the director of the Infrastructure Analysis and Planning Directorate, leading a team of analysts on energy infrastructure security and reliability projects. From 2009 to 2012, Ms. Lippert was responsible for implementing the American Recovery and Reinvestment Act State and Local Energy Assurance Planning Initiative, a \$50 million grant program involving 47 states, the District of Columbia, 43 cities, and 2 territories. In 2016, she received the Secretary of Energy's Distinguished Service Award. Prior to joining the current office, Ms. Lippert was employed as an energy economist with the Energy Information Administration, where she served as one of the resident senior petroleum analysts and managed several large energy data collection surveys. She was also responsible for conducting economic analyses related to the energy industry; authored market assessment reports; and assessed changes in the energy industry as a result of legislation or environmental laws and regulations. Early in her career, she was employed as an economist for the Bureau of Labor Statistics' Consumer Expenditure Survey. Ms. Lippert holds an M.S. from the University of Wisconsin.

**M. SAM MANNAN**, Ph.D., is the Regents Professor of Chemical Engineering at Texas A&M University, as well as the director of the Mary Kay O'Connor Process Safety Center. Dr. Mannan holds concurrent joint appointments as professor of mechanical engineering, petroleum engineering, industrial and systems engineering, and materials science and engineering at Texas A&M. Before joining Texas A&M, Dr. Mannan was vice president at RMT, Inc., a nationwide engineering services company. Dr. Mannan is a registered professional engineer, a certified safety professional, and a professional process safety engineer. His experience covers process design of chemical plants and refineries, computer simulation of engineering problems, mathematical modeling, process safety, risk assessment, inherently safer design, critical infrastructure vulnerability assessment, aerosol modeling, and reactive and energetic materials assessments. Dr. Mannan is involved with projects that include hazard assessment and risk analysis, process hazard identification, hazard and operability studies, vulnerability assessment, process safety management, and risk management. His research interests include the development of inherently safer processes, application of computational fluid dynamics to study the explosive characteristics of flammable gases, development of quantitative methods to determine incompatibility among various chemicals, application of calorimetric methods for the assessment of reactive hazards, and the application of consequence analyses to assess the impact of process plant incidents. He co-authored the *Guidelines for Safe Process Operations*



## STRENGTHENING POST-HURRICANE SUPPLY CHAIN RESILIENCE

*and Maintenance*; and he is the editor of the authoritative reference for process safety and loss prevention, *Lees' Loss Prevention in the Process Industries*. Dr. Mannan has published 299 peer-reviewed journal publications, 5 books, 8 book chapters, 220 proceedings papers, 14 major reports, and 272 technical meeting presentations.

**CRAIG E. PHILIP**, Ph.D. (NAE), is research professor of civil and environmental engineering at Vanderbilt University, and director of Vanderbilt's Transportation Center (VECTOR). Dr. Philip's research focus includes infrastructure sustainability, and the application of risk management tools to transportation systems, carrier safety management, and transport policy and regulation with a particular focus on maritime systems. Dr. Philip spent 35 years in the rail, intermodal, and maritime industries, including Conrail and Southern Pacific Railroads. He joined Ingram in 1982 and from 1999 until 2014 served as president/ chief executive officer of Ingram Barge Company, the largest U.S. marine transport carrier. He served as chairman of multiple maritime groups including the American Waterways Operators, National Waterways Conference, and National Waterways Federation; was a U.S. commissioner of the World Association for Waterborne Transport Infrastructure (PIANC); and chaired the U.S. Chamber of Commerce's Transportation and Infrastructure Committee. He has served on the executive committee of the Transportation Research Board and is currently a member of its Marine Board and Resilience Section. Dr. Philip currently serves on the boards of the ArcBest Corporation (a publicly traded trucking firm), Seamen's Church Institute, and the Nashville Civic Design Center. Dr. Philip earned his doctorate in civil engineering from the Massachusetts Institute of Technology and his bachelor's degree from Princeton University. He is a board-certified member of the American Academy of Environmental Engineers and Scientists, and a member of the National Academy of Engineering.

**KEVIN SMITH** is a career supply chain practitioner and the president and chief executive officer of Sustainable Supply Chain Consulting. Sustainable Supply Chain Consulting was founded in 2009 to provide advice and guidance to large-scale supply chains and related businesses concerning strategic planning and organizational development. Mr. Smith served for eight years as senior vice president of supply chain and logistics for CVS/pharmacy, the retail arm of CVS Caremark, where his role was to facilitate changes in the overall supply chain. He also served as corporate sustainability officer for CVS/Caremark. Mr. Smith has been a longtime board member for the Council of Supply Chain Management Professionals, special advisor to Supply Chain 50, and contributor to the Retail Industry Leaders Association. Mr. Smith is also vice chair of the Distribution Business Management Association Supply Chain Leaders in Action Executive Committee and served as the 2017 chairman of the Massachusetts Institute of Technology Center for Transportation and Logistics advisory board. Mr. Smith is a graduate of the University of Massachusetts with a B.A. in English.